

Kingston

Providence
Care



Standardized

Cognitive

Assessment

- Revised

(KSCAR)

Administration and Scoring Manual

Seniors Mental Health, Providence Care Mental Health Services, Kingston, Canada K7L 4X3

The Kingston Scales and Manuals can be downloaded free of charge from:

www.kingstonscales.ca

email: kcales@queensu.ca

© Copyright 1993...2015 R.W. Hopkins, L.A. Kilik

TABLE OF CONTENTS		
Introduction		3
SUB-TEST SCORING		
1	Orientation	5
2	Remote Memory	6
3	Digit Repetition	7
4	Word Recall	9
5	Visual Memory	10
6	Word Finding	16
7	Reading Comprehension	17
8	Abstract Thinking	18
9	Calculation	19
10	Writing	20
11	Right/left Orientation	21
12	Verbal Comprehension	22
13	Delayed Word Recall	23
14	Word Recognition	24
15	Copying	25
16	Spatial Reversal	30
17	Ideomotor	32
18	Clock Drawing	33
19	Perseveration	40
Observations During Examination		424
KSCA-r Score Analysis Pages		447
Maximum Scores		
NORMATIVE DATA		
	Total Score Percentiles (Normals and Dementia - to nearest 5 percent)	48
	Normal Group Statistics and Percentiles	49
	Alzheimer's Disease Group Statistics and Percentiles	51
	Alzheimer's Disease Education Norms	56
	Elementary School Percentiles	57
	High School Percentiles	61
	Post Secondary School Percentiles	65
	Other Dementias Group Statistics and Percentiles	69
	Depression Group Statistics and Percentiles	74
Normative Subject Frequency Distribution Charts		78



Introduction

The Kingston Standardized Cognitive Assessment-Revised (KSCAr) (see refs below) is an instrument designed to quickly assess individuals suspected of having brain damage; especially progressive dementias in the elderly. It is a broad range test that can assess a number of cognitive capabilities but concentrates on those commonly associated with dementia. It produces a comprehensive assessment of memory, language, and visual-motor functions, yielding a percentile score for each, as well an overall total score. Individuals can be compared to two groups of outpatients with progressive dementias (Alzheimer and Other Dementia groups) as well as a community dwelling normal elderly sample. Norms are also provided for a group of out-patients who were diagnosed with depression, but not dementia. While it is not diagnostic, the KSCAr alerts the user to the possibility of an existing organic process and raises the question of whether further evaluation is needed.

One of the main values of the KSCAr is that it provides perhaps the most comprehensive screening of potentially brain damaged patients that can be obtained without special training or specially trained personnel, and can typically be completed in about 30 minutes.

The companion to this manual is the "Assessment Form" which is the protocol used to assess a patient and contains all of the forms necessary; only a pencil needs to be provided.

In addition to the KSCAr, there is the *BriefKSCAr* which is a shorter version that can be used to monitor a patient's change over time; and it can be completed in 15 minutes. While the full KSCAr is recommended for initial or more comprehensive screening, especially when the scope of the possible brain damage is unclear, the *BriefKSCAr* can also be used as a fast and reliable bedside procedure that yields far more data than other cognitive screening tools commonly in use, such as the MMSE.

General Scoring Notes:

- Many elderly people have some degree of hearing loss; make sure the patient understands the questions and instructions. Speak slowly and clearly; ask him/her to let you know if he/she has trouble understanding you. Repeat if necessary. In addition, many patients have some degree of visual impairment; make sure the patient can see the designs and pictures adequately.
- If the patient has enough difficulty in hearing instructions or seeing the designs to make interpretation of the results questionable, **DO NOT SCORE THOSE ITEMS.**
- If the patient gives a wrong response but corrects him/herself spontaneously, **BEFORE** starting the next sub-test, the second response **IS** scored; but **DON'T** use the self-corrected answers that occur after you have gone on to something else, use the original response for scoring purposes.
- If you wish to probe a patient further (i.e., "testing the limits") you may do so; make note of any additional responses, but **SCORE ONLY THE ORIGINAL RESPONSE.**
- **WRITE DOWN ALL RESPONSES.** The response lines are provided not just to make occasional notes but to make the KSCAr a complete record of the assessment that can be compared to future examinations.
- **IF A SUB-TEST IS NOT SCORED FOR ANY REASON, A TOTAL SCORE CANNOT BE OBTAINED, HOWEVER A SUB-TOTAL THAT DOES NOT USE THAT SCORE MAY BE COMPUTED.**

For psychometric properties see:

Rodenburg M, Hopkins R, Hamilton P, Ginsburg L, Nashed Y, Minde N. 1991. The Kingston Standardized Cognitive Assessment. *Int J Geriatr Psychiatry* **6**: 867-874.

Hopkins R, Kilik L, Day D, Rows C, Hamilton P. 2004. The Revised Kingston Standardized Cognitive Assessment. *Int J Geriatr Psychiatry* **19**, 320-326.

Introduction

The Use of This Manual

While each Assessment Form contains administration instructions and some statistical data, this manual does so in greater detail, and in addition, information about the scoring and interpretation of the KSCAr. Each sub-test sections is organized under the same headings: **Name, Purpose, Administration Instructions** (with what the examiner actually says to the patient shown in **UPPER CASE AND BOLDED**), **Scoring Procedure, Maximum Total Score, Acceptable Answers** (and sometimes unacceptable answers), **Interpretation, Templates** (where applicable), and **Examples** (where applicable).

One feature found in the KSCAr that is rarely found in other scales, is the provision of templates to aid in scoring the items where the subject is asked to draw something. The templates are produced in the proper size to allow the examiner to place the patient's reproduction over top of the template to determine whether the angles or spacing etc, is correct. Also included with many of the sub-tests, especially the ones requiring drawing, are examples of some common responses which are reproduced to aid in distinguishing between 0, 1, or 2 point answers.

While each sub-test has an interpretation section, this is only intended as a guide. Those listed are common interpretations, used most frequently when a patient is suffering from a progressive dementia such as Alzheimer's Disease. However, where different etiologies are involved, alternative interpretations may be applicable.

An important part of the KSCAr is the section entitled "Behaviour at Time of Examination". This is a simple checklist for the clinician to make observations about the behaviour of the patient during assessment. It allows one to make note of language and other important behaviours. It is particularly useful for picking up behaviour changes that are not noted by cognitive assessment alone.

Before administering the KSCAr for the first time, one should carefully read this manual and examine the Assessment Form. It is advisable to give a practise assessment or two on a colleague, or family member. Total or raw scores are not reported when interpreting the KSCAr. Percentiles are used to describe performance. After scoring the KSCAr and recording the scores on the Scoring Summary sheet of the Assessment Form, compare the scores to the "Score Analysis Pages" found after the Scoring Summary. To help understand the use and interpretation of these pages, read the page entitled "KSCAr Score Analysis" found on page 41 of this manual. Also, determine the percentiles for the scores of the three Sub Totals. These are found for dementia (Alzheimer's) patients at the end of the Assessment Form, and for normals and other pathology groups in this manual.

This manual contains statistics (i.e. means, percentiles, etc.) for groups of normal elderly (p. 45), Alzheimer's patients (p. 47), patients suffering from other forms of progressive dementias (p. 52), and a group of depressed patients (p. 56). The group labelled "**Dementia**", on page 44 and in the "Analysis Forms" is in fact the **Dementia - Alzheimer's group**. When newly assessing a patient for whom there is no definitive diagnosis, this group should be used for a first comparison. If the individual is known, or suspected of having a diagnosis compatible with one of the other groups, then that group can be used for comparison purposes. It should be noted that the Alzheimer's group used in these norms is drawn from a mostly community living sample (i.e. over 90% of the sample lived in the community either with or without supports). It is important to consider the type of patient when interpreting the scores.

A more complete and effective assessment of a suspected dementia should also include a behavioural assessment, such as can be obtained by using the Kingston Standardized Behavioural Assessment (KSBA) (Hopkins R, Kilik L, et al, (2006) *Am J Alz Dis*, **21**: 339-346.).



SUBTEST NO. 1		ORIENTATION
Purpose	To assess recent memory through general level of orientation to person, time and place.	
Administration Instructions	Ask each as presented in quotation marks below. [REMEMBER TO WRITE DOWN ALL RESPONSES]	
Scoring Procedure	One point per question is given for each correct response.	
Maximum Total Score	10	
Interpretation	A poor performance suggests problems with short term or recent memory. This is a common finding in typical dementias such as Alzheimer's disease but is not necessarily a prominent feature in other forms of dementia. Especially those that are not progressive such as delirium.	
Acceptable Answers		
1. "WHAT IS YOUR FULL NAME?"	- at least one given name & last name	
2. "WHAT IS YOUR AGE?"	- age, not 'date of birth', if they give DOB say "Yes, but how old does that make you."	
3. "WHAT IS YOUR BIRTH DATE?"	- date of birth, not 'birthday'	
4. "WHERE ARE WE NOW?"	- at least 'hospital', or type, or name of institution - whatever type of building it is (e.g., house, apartment, nursing home)	
5. "WHAT CITY (TOWN etc.) IS THIS?"	- name of city, town, village (not subdivision)	
6. "WHAT DAY OF THE WEEK IS THIS?"	- correct day	
7. "WHAT MONTH IS THIS?"	- correct month	
8. "WHAT YEAR IS THIS?"	- correct year	
9. "WHAT IS THE TIME OF DAY?"	- correct time within 90 min.	
10. "WHAT IS THE SEASON?"	- correct season	



SUBTEST NO. 2		REMOTE MEMORY
Purpose	To assess long term memory.	
Administration Instructions	Ask each as presented in quotation marks below.	
Scoring Procedure	NOT USED IN TOTAL SCORE	
Maximum Total Score	5	
Interpretation		
Acceptable Answers		
1. "WHERE WERE YOU BORN?"	- town, or location compared to a known location, e.g., north of Napanee	
2. "WHERE DID YOU GO TO SCHOOL?"	- name or location of school	
3. "WHAT WAS YOUR FATHER'S NAME?"	- given name	
4. "WHAT WAS YOUR MOTHER'S NAME?"	- given name	
5. HOW MANY BROTHERS AND SISTERS DID YOU HAVE?"	- number of each, not their names	
Interpretation	Due to the difficulty in most cases in confirmation of the responses, the results of this test are not used in the Total Score calculation. A degradation of over-learned material such as above usually is only seen in more advanced dementias. The examiner should be alert to the patient's level of spontaneity in responding to questions.	



SUBTEST NO. 3a	DIGIT REPETITION - Forward
Purpose	To assess immediate memory and concentration.
Administration Instructions	<p>Speak in an even tone of voice, but let the pitch of the voice drop on the last digit of each trial. Give each digit at the rate of 1 digit per second and record all responses. Administer Trial II only if patient fails Trial I. Discontinue when subject fails both Trials.</p> <p>Say "I AM GOING TO SAY SOME NUMBERS. LISTEN CAREFULLY, AND WHEN I AM THROUGH, SAY THEM RIGHT AFTER ME."</p> <p>If a patient asks you to repeat a number or string of numbers, say "I WILL GIVE YOU ANOTHER ONE", and continue. Do not repeat numbers. If patient continually asks for repeats, assess their hearing before continuing. Be sure to raise your voice and speak slowly and clearly.</p>
Scoring Procedure	1 Point for each correct response, regardless of whether it was Trial I or Trial II. 0 Points when both Trials I and II are failed.
Maximum Total Score (Forward)	5
Interpretation	Problems in immediate memory are not usually evident in progressive dementias until other types of memory deficits are apparent. Digits forward is a measure of auditory immediate (working) memory, sequencing, and freedom from distractability. This task is more sensitive to left-hemisphere damage than to diffuse or right hemisphere damage.
Acceptable Answers	- must be the correct number sequence



SUBTEST NO. 3b		DIGIT REPETITION - Backwards
Purpose	To assess the ability to mentally manipulate numbers.	
Administration Instructions	<p>Speak in an even tone of voice, but let the pitch of the voice drop on the last digit of each trial. Give each digit at the rate of 1 digit per second and record all responses. Administer Trial II only if patient fails Trial I. Discontinue when subject fails both Trials.</p> <p>Say "NOW I AM GOING TO SAY SOME MORE NUMBERS, BUT THIS TIME WHEN I STOP, I WANT YOU TO SAY THEM BACKWARDS. FOR EXAMPLE, IF I SAY 7-1-9, WHAT WOULD YOU SAY?"</p> <p>If a patient asks you to repeat a number or string of numbers, say "I WILL GIVE YOU ANOTHER ONE", and continue. Do not repeat numbers. If patient continually asks for repeats, assess their hearing before continuing. Be sure to raise your voice and speak slowly and clearly.</p>	
Scoring Procedure	1 Point for each correct response, regardless of whether it was Trial I or Trial II. 0 Points when both Trials I and II are failed.	
Maximum Total Score	4	
Interpretation	In the reversal of digits, the numbers must be held in mind and reordered. This is a much more difficult task than simply repeating them. Large discrepancies between forward and backward often reflect the kind of diffuse damage that occurs with many dementing illnesses, and is more sensitive to brain dysfunction than digits forward, overall.	
Acceptable Answers	- must be the correct number sequence	



SUBTEST NO. 4		WORD RECALL
Purpose	To assess short term verbal memory	
Administration Instructions	<p>Use the 10 word list (TABLE, FOOTBALL, WINDOW ... APPLE). Using a blank sheet of paper (supplied), slide it down the list of words, sequentially exposing the list one word at a time. Present each word for 2 seconds. Ask the subject to “PLEASE READ ALOUD EACH WORD THAT I SHOW YOU.”</p> <p>DO NOT TELL THE SUBJECT TO TRY AND REMEMBER THEM. After presenting all 10 words, cover the list completely or otherwise ensure that it is not visible and ask the subject “PLEASE TELL ME AS MANY OF THE WORDS FROM THAT LIST AS YOU CAN, IN ANY ORDER.”</p>	
Scoring Procedure	1 Point for each correct response.	
Maximum Total Score	10	
Interpretation	Poor performance on short term recall tasks such as this is a common feature in most forms of brain damage.	
Acceptable Answers	The recalled words must be exact, no synonyms.	

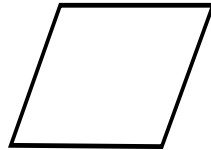

Design 1

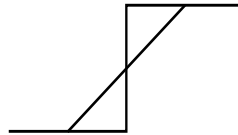

Design 2

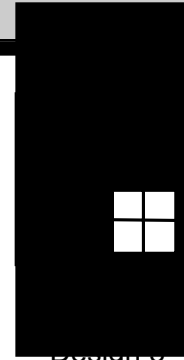

Design 3

SUBTEST NO. 5		VISUAL MEMORY
Purpose	To assess short term visual memory	
Administration Instructions	Hand patient a blank page and a pencil with eraser and say: "HERE IS A PIECE OF PAPER FOR YOU. I AM GOING TO SHOW YOU A FIGURE. I WOULD LIKE YOU TO STUDY IT FOR 10 SECONDS AND THEN I WILL TAKE IT AWAY AND I WANT YOU TO DRAW IT FROM MEMORY." Remove design after 10 sec.; repeat instructions for each design as you hand patient another blank page.	
Scoring Procedure	General Remarks: - any size is acceptable; - drawings should be reasonably neat, i.e., lines reasonably straight, corners almost closed; - if the patient rotates the page indicate top of page with an arrow.	
Maximum Total Score	6	
Acceptable Answers for Design 1	GENERAL SHAPE: Parallelogram with 4 sides of equal length, 2 acute and 2 obtuse angles, resting on a side and leaning to the right. 2 Points - approximate shape of a parallelogram leaning to the right; - no right angles; - all four sides should be approximately equal in length; - the longer side cannot be longer than twice the shorter side; - rotated less than 15 degrees, i.e., within shaded area (Figure A) 1 Point - a 4-sided figure where no side is longer than approximately 1 ½ times its opposite, or a square	
Templates	Design 1 - use Figure A to determine position of base line. Place lower left corner of subject's drawing over lower left corner of template. Rotate figure so that left vertical line of subject's drawing is over left vertical side of template. The base line of subject's drawing should fall in the shaded area.	

SUBTEST NO. 5	VISUAL MEMORY
<p>Acceptable Answers for Design 2</p>	<p>GENERAL SHAPE: 3 lines of equal length (the longest being no more than twice the shortest) forming a "square S", each of the three lines forming the "square S" is equally bisected (within the middle third) by a diagonal.</p> <p>2 Points - must reasonably conform to general shape ("square S" with a diagonal line through it); - vertical line of the Squared S rotated less than 30 degrees either way, i.e., when subject's drawing is placed over Figure B with lower horizontal lines overlapping, the vertical line of the drawing should be in the shaded area; - top and bottom horizontal lines of the Squared S approximately parallel to each other; - vertical line of the Squared S bisected within the central third of its length by the diagonal (Figure C - a); - diagonal almost touches or does not extend beyond top and bottom horizontal lines of the Squared S (by not more than approx. 10% of its length) (Figure C - area marked b)</p> <p>1 Point - general shape is recognizable with either "Squared S" or diagonal line drawn correctly;</p> <p>- a reversed or rotated figure (45 degrees or more) loses 1 more point</p>
<p>Acceptable Answers for Design 3</p>	<p>GENERAL SHAPE: large square with 2 diameters; small square with 2 diameters in right lower section of large square ("small window within large window")</p> <p>2 Points - BOTH windows complete and correctly placed (i.e. small window must be placed in lower right quadrant of large window); - all four sides of the window are approximately the same length (the long side of each window should be no more than twice the short side); - rotated less than 15 degrees, i.e., when subject's drawing is placed over template so that left edge of square is over left edge of template, neither the upper or lower horizontal sides of the large square should be rotated beyond the shaded areas (Figure D - a); - cross within each window centred within a quarter of the distance between the centre point and outside boundaries (i.e. each intersecting line should bisect the other between 1/4 and 3/4 of its length); - small window must not share lines with large window</p> <p>1 Point - at least one window complete: If large window is complete, small window may be either absent or transformed or placed in another quadrant, e.g., it may have no outer boundaries; or more or less than two diameters; or it may contain other features; - if small window is complete and correctly placed, large window may be inaccurate or incomplete, e.g., have no diameters, or only one.</p>
<p>Interpretation</p>	<p>This task measures visuoperceptual, constructional, and spatial organizational abilities. It is generally sensitive to non-dominant hemisphere functioning, most notably right temporoparietal integrity.</p>



KSCAr

Figure A

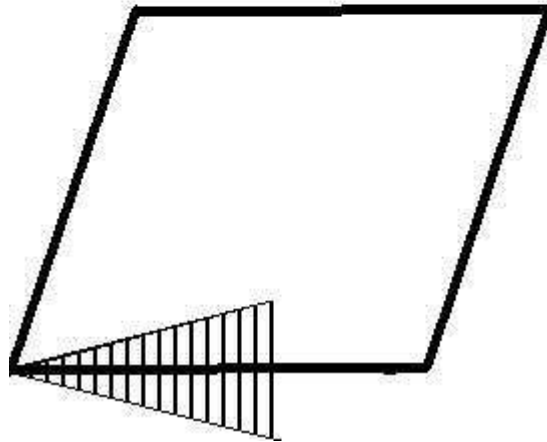

Example: - Design 1

2 Points

1 Point

0 Points

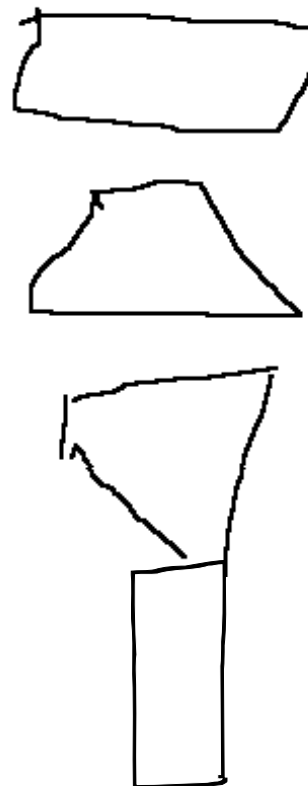
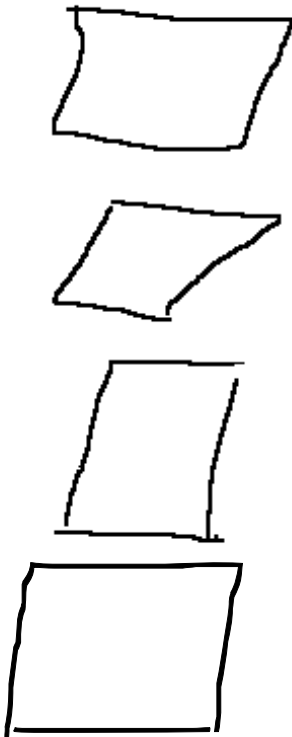

Templates: - Design 2

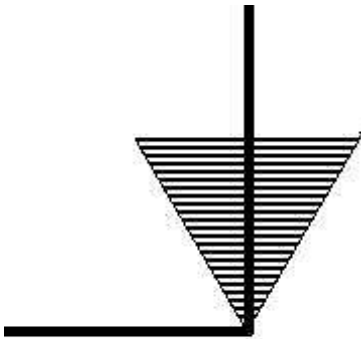

Figure B

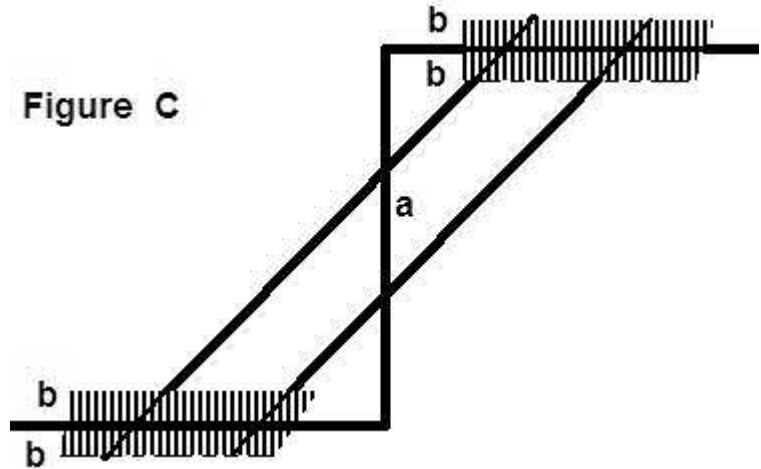

Figure C

Template: - Design 3

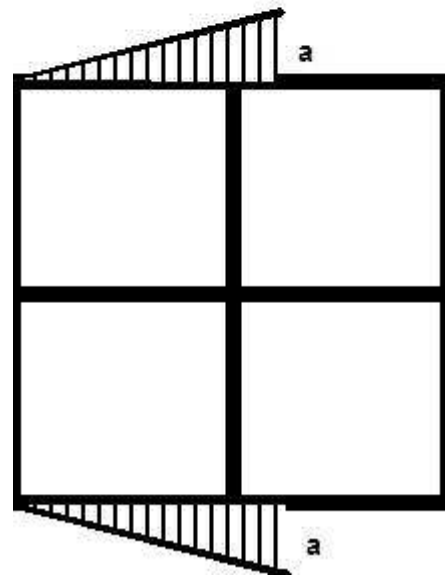

Figure D

Examples: - Design 2

2 Points

1 Point

0 Points

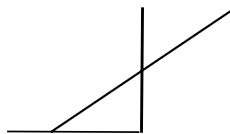
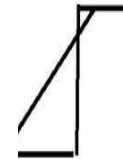
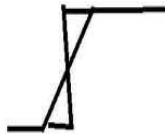
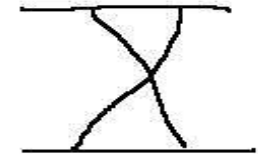
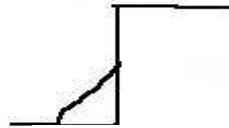
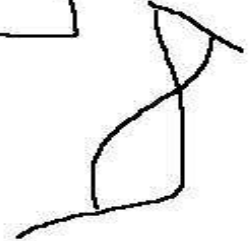
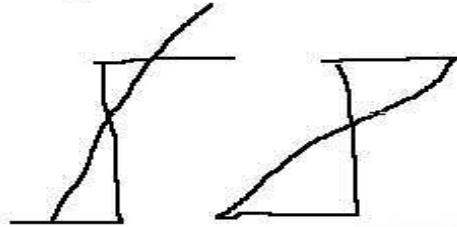
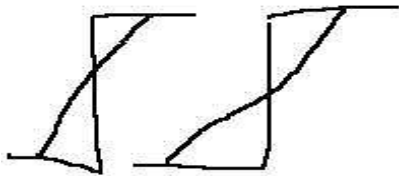
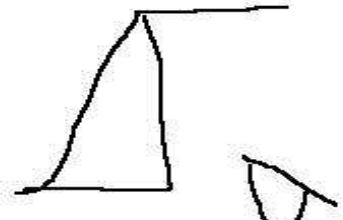
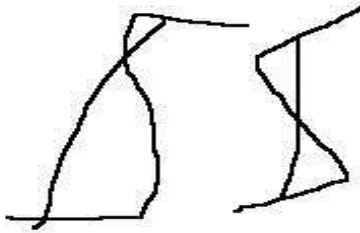
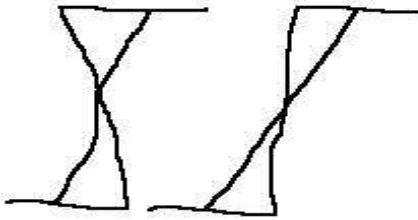

Examples: - Design 3

2 Points

1 Point

0 Points

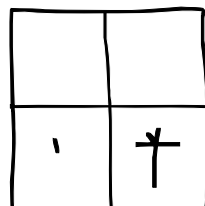
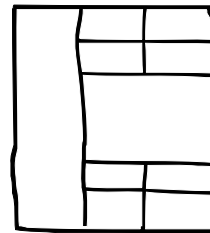
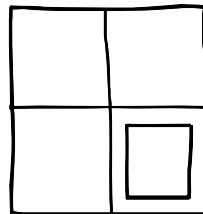
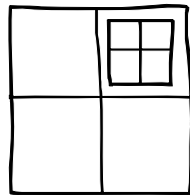
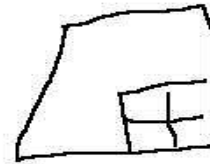
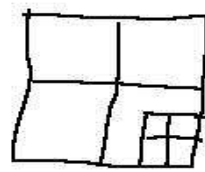
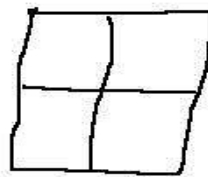
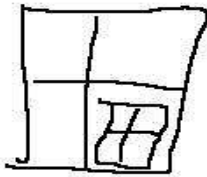
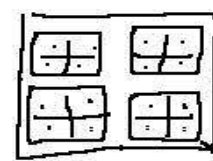
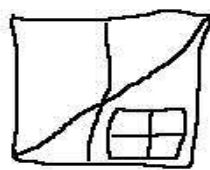
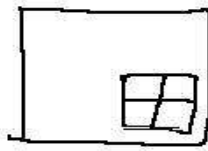
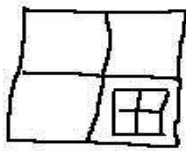
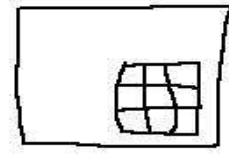
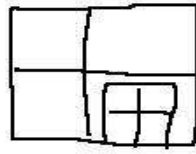
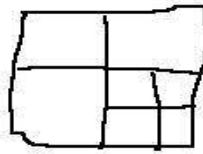
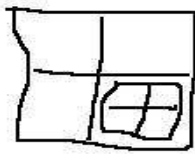



SUBTEST NO. 6		WORD FINDING
Purpose	To assess one's ability to find the correct word in response to visual stimulus.	
Administration Instructions	For items 1 to 8 point to each of the pictures in turn and say "TELL ME WHAT YOU CALL THIS." For items 9 and 10, point carefully to the picture of the bicycle (e.g. trace 1 or 2 spokes, circle pedals with pencil) and say "TELL ME WHAT YOU CALL THIS."	
Scoring Procedure	1 Point for each picture or detail correctly named	
Maximum Total Score	10	
Interpretation	Nominal aphasia or the loss of the ability to name objects, occurs when there is damage to certain verbal areas of the brain. Performance on confrontation naming tasks may be a function of several factors, including age, education, accumulated vocabulary and cultural linguistic background. However, deficits in this ability have been shown to distinguish between normal aging and early dementia populations.	
Acceptable Answers	<ol style="list-style-type: none">1. KITE2. BICYCLE3. SPADE [or SHOVEL]4. FOOT5. BOTTLE [or other word containing bottle, e.g., WINE BOTTLE]6. UMBRELLA7. ELEPHANT8. CHIMNEY [NOT 'smoke stack']9. SPOKES10. PEDALS [NOT 'brakes']	



SUBTEST NO. 7		READING COMPREHENSION
Purpose	To assess one's ability to read and comprehend a written passage.	
Administration Instructions	"NOW I WOULD LIKE YOU TO READ A SHORT STORY AND THEN I WILL ASK YOU SOME QUESTIONS ABOUT IT. PLEASE READ SO THAT I CAN HEAR YOU." Hand patient the story page; let him/her keep it until all questions are answered.	
Scoring Procedure	1 Point for each correct response. NOTE: If patient is unable to read the passage, read it to him/her, but do not score it.	
Maximum Total Score	3	
Interpretation	Failure to be able to read, or more commonly, be able to read but not extract any information, is another indication of damage to the language areas of the brain.	
Acceptable Answers		
"What City Was Mr. Davis Travelling To?"	Toronto	
"How Did He Intend to Get There?"	By bus	
"Where Was His Daughter Driving Him?"	To the bus terminal (or bus station, or 'to the bus')	



SUBTEST NO. 8		ABSTRACT THINKING
Purpose	To assess one's ability to perform abstract reasoning.	
Administration Instructions	Ask each question as written. Prompt responses only on the first two.	
Scoring Procedure	General Remarks: 2 Points - highest level of appropriate abstraction or major use 1 Point - minor similarities; superficial or descriptive only	
Maximum Total Score	8	
Interpretation	Difficulties with this task suggest problems in abstract reasoning, which is an executive function often associated with frontal lobe damage.	
Acceptable Answers		
1. "In what way are carrots and beans alike?"	2 Points - vegetables; you eat them; food; 1 Point - have vitamins; grow in ground; plants; If patient fails to give a 2-point answer say, "THEY ARE BOTH VEGETABLES."	
2. "In what way are a shirt and a sweater alike?"	2 Points - clothing; apparel; attire; you wear them; 1 Point - they are made of cloth (material); have sleeves (buttons); cover upper part of the body; [same help as above]	
3. "In what way are a dog and a cow alike?"	2 Points - animals (mammals); 1 Point - they have 4 legs; are found on farms. [no help]	
4. "In what way are a car and a bicycle alike?"	2 Points - means of transportation (travelling); vehicles; - they take you places; you ride them; 1 Point - they have wheels; carry people; you steer them. [no help]	



SUBTEST NO. 9		CALCULATION
Purpose	To assess one's ability to do mental arithmetic.	
Administration Instructions	This is an aurally administrated sub-test. Say "I WANT TO ASK YOU A FEW MORE QUESTIONS: HOW MUCH IS" ... "TWO PLUS FOUR" "NINE MINUS TWO" "FIVE TIMES FIVE" "FIFTY-SIX DIVIDED BY SEVEN"	
Scoring Procedure	1 point for each correct answer. If patient gets a score of '0' on an early item (e.g., 2+4) but gets full marks on more difficult items, return to the failed item before moving on to the next test; if on second try he/she gets it right, make a note of this, but don't change the score. If patient spontaneously corrects himself/herself before beginning the following test, change score to '1'.	
Maximum Total Score	4	
Interpretation	Problems with this task often indicate an inability to concentrate, even for a short period of time. This task has also been shown to be sensitive to organizational and executive (concept-formation) difficulties.	
Acceptable Answers	Answer must be correct	



SUBTEST NO. 10		WRITING
Purpose	To assess one's ability to write down familiar information.	
Administration Instructions	Use the blank page 21 for the patient to write on. "NOW I WOULD LIKE YOU TO WRITE SOMETHING: FIRST, YOUR NAME, PLEASE." . When patient has done so, say, "AND NOW I WANT YOU TO WRITE: KINGSTON, ONTARIO, CANADA." * Repeat, if patient forgets * use a more familiar local address (of similar length) if the patient is not from Kingston. <i>Note: Patient must write (i.e. use script) not print. If patients start to print, correct them, if they persist, score is 0.</i>	
Scoring Procedure	1 Point each for: patient's name Kingston (city) Ontario or Ont. or ON (province or state) Canada (country) A loss of one point per section if one or more letters are missing or are unrecognizable.	
Maximum Total Score	4	
Interpretation	Writing is another form of linguistic skill and is often disrupted by various forms of brain damage	
Acceptable Answers	Responses must be legible and spelled correctly	



SUBTEST NO. 11		RIGHT/LEFT ORIENTATION
Purpose	To assess one's spatial orientation to right and left.	
Administration Instructions	Ask the patient to "TOUCH YOUR LEFT SHOULDER." Then ask the patient to "POINT TO MY ..." various body parts. NOTE: slower response times are common in the elderly.	
Scoring Procedure	NOTE: while Right/Left Orientation and Verbal Comprehension are run together as one task, they are scored separately as two distinct tasks. 1 Point for each correct right/left response Also note, that if a patient uses his or her own body to respond to questions 8, 9, or 10, then both body part and R/L are scored as incorrect.	
Maximum Total Score	10	
Interpretation	Right/left discrimination is a spatial ability that is often disrupted in moderate to severe brain damage. This task is also sensitive to mental rotation, conceptual abilities and hand preference.	



SUBTEST NO. 12		VERBAL COMPREHENSION
Purpose	To assess one's ability to comprehend spoken instructions.	
Administration Instructions	Ask the patient to "TOUCH YOUR LEFT SHOULDER." Then ask the patient to "POINT TO MY ..." various body parts.	
Scoring Procedure	NOTE: while Right/Left Orientation and Verbal Comprehension are run together as one task, they are scored separately as two distinct tasks. 1 - point for each body part touched correctly Also note, that if a patient uses his or her own body to respond to questions 8, 9, or 10, then both body part and L/R are scored as incorrect.	
Maximum Total Score	10	
Interpretation	Verbal comprehension is another form of communication skill that is often disrupted as a result of brain damage.	



SUBTEST NO. 13		DELAYED WORD RECALL
Purpose	To assess short term verbal memory with a delay of 10 to 15 minutes.	
Administration Instructions	After 15 minutes (approximately) ask the subject “PLEASE TELL ME AS MANY WORDS THAT YOU CAN REMEMBER FROM THE LIST THAT I SHOWED TO YOU EARLIER, IN ANY ORDER.”	
Scoring Procedure	1 Point for each correct response	
Maximum Total Score	10	
Interpretation	A delay between learning and recall is not usually problematic for someone without brain damage, but if brain damage is present it often shows up as a reduced capacity to remember material after a delay. This is often one of the first signs of brain damage.	
Acceptable Answers	Responses must match the words on the list exactly. Substitutions or intrusions are not scored but should be noted.	

SUBTEST NO. 14	WORD RECOGNITION
Purpose	To assess one's ability to make use of partial information in assisting one to recognize learned material.
Administration Instructions	<p>After completing the delayed recall, show the subject the second list of 20 words [2 sheets] (TABLE, HOUSE, BOWL, .. BIRD), point to the first word and say to the subject "DID YOU SEE THIS WORD ON THE LIST THAT I SHOWED TO YOU EARLIER OR IS THIS A NEW WORD?"</p> <p>Repeat these instructions for the 2nd word. But for the 3rd word say "HOW ABOUT THIS ONE?"</p> <p>For the 4th word onward, use either instruction as seems necessary. After completing the 1st page, go to the second one (GLOVE, KING)</p>
Scoring Procedure	1 Point for each word correctly identified as being either "in" or "not in" the list. Divide points by 2 for total score out of 10. i.e. $IN/10 + NOT\ IN/10 = Total/20 \div 2$ (max = 10)
Maximum Total Score	10
Interpretation	Usually patients suffering from Alzheimer's disease will perform relatively poorly on free recall and delayed recall, but will perform at near normal levels on recognition memory.

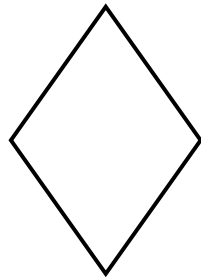

Design 1

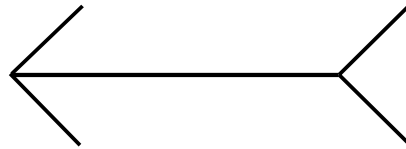

Design 2

SUBTEST NO. 15a		COPYING - Diamond
Purpose	To assess one's ability to copy a figure with the stimulus still in front of them.	
Administration Instructions	<p>"HERE I HAVE A FIGURE FOR YOU TO COPY" [avoid naming designs]. If the patient inquires or is uncertain what to do, say "COPY IT IN THE SPACE PROVIDED HERE." [point to space on page]</p>	
Scoring Procedure for Diamond	<p>GENERAL SHAPE: 4 sides of equal length; resting on a corner; height exceeding width.</p> <p>2 Points</p> <ul style="list-style-type: none"> - height exceeding width; - vertical axis rotated less than 15 degrees either way, i.e., when subject's copy is placed on template Figure E with lower point placed at conversion of lines (C) and lower left side along left side of template(line CL), the upper point of drawing should fall into the shaded area marked 'a' (or its extension). - horizontal axis rotated less than 15 degrees either way, i.e., when subject's copy is placed on template Figure F with left point placed at conversion of lines (C) and lower left side along left side of template (line CL), the right point of drawing should fall into the shaded area marked 'a' (or its extension). <p>Check other corners by turning drawings up-side-down. (Note that Figure F is Figure E rotated 90 degrees).</p> <p>1 Point</p> <ul style="list-style-type: none"> - vertical axis rotated less than 35 degrees either way. Use Figure E as above, but upper point should fall into white area marked b. - horizontal axis rotated less than 35 degrees either way. Use Figure F as above, but upper point should fall into white area marked b. - neither upper nor lower corner should have an angle greater than 130 degrees. Use Figure G to measure the angle. 	

Templates:

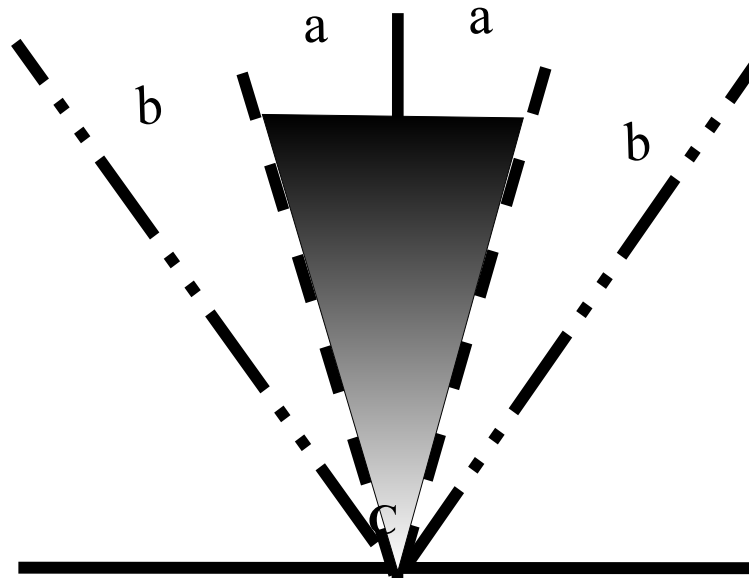

Figure E

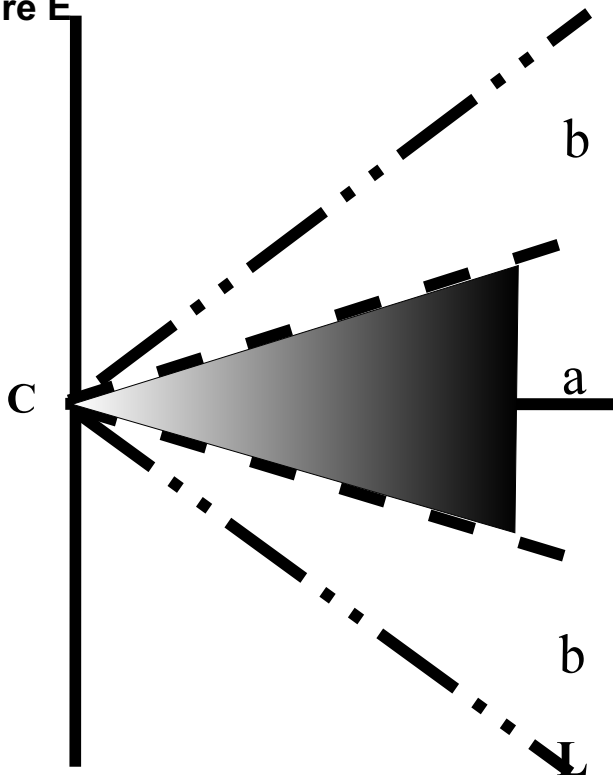
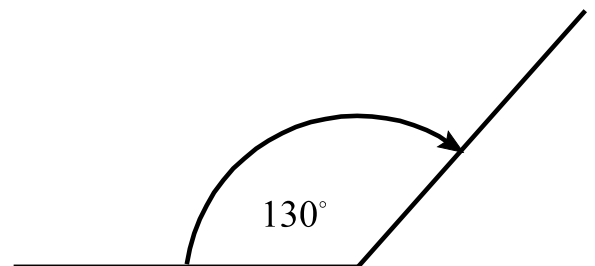

Figure G

Figure F



Examples:

2 Points



1 Point

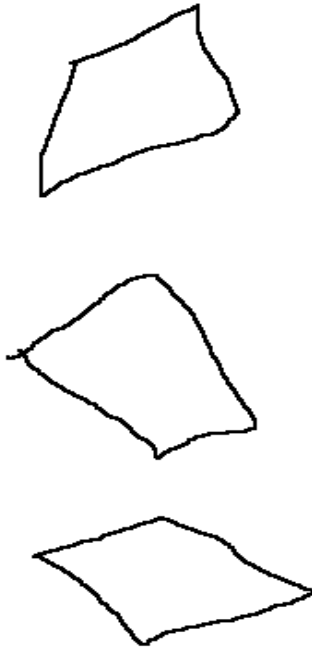

0 Points

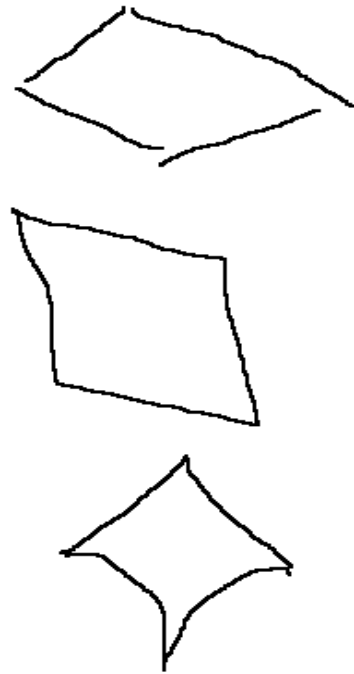

SUBTEST NO. 15b		COPYING - Arrow
Scoring Procedure for Arrow	<p>- GENERAL SHAPE: 2 corners connected by horizontal line. If patient's 'arrow' is too different from figure to be copied remind him/her that you asked him/her to "copy this figure".</p> <p>2 Points - General shape preserved;</p> <p>- Horizontal axis rotated less than 10 degrees. Using Figure H place right edge of drawing parallel to right edge of template so that right vertex is on point 'C'. 'Shaft' of arrow should be within shaded area marked 'a';</p> <p>- arrow pointing in appropriate direction.</p> <p>1 Point - Some distortion of shape acceptable;</p> <p>- Horizontal axis rotated less than 15 degrees. Use Figure H as above, but 'shaft' of arrow should be within the lines marked 'b';</p> <p>- horizontal line overlapping or not touching 'point' or 'tail' within 10% of its length.</p>	
Maximum Total Score	4	
Interpretation	<i>Problems with copying are usually associated with parietal lobe damage.</i>	

Template: -

Figure H

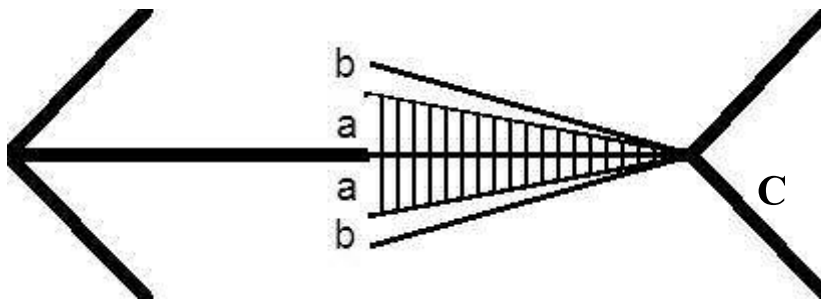

Examples: -

2 Points

1 Point

0 Points

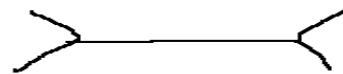
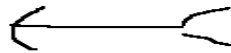
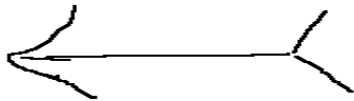
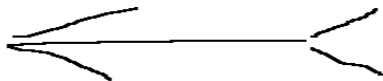
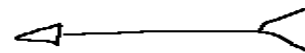
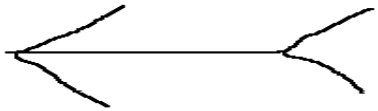
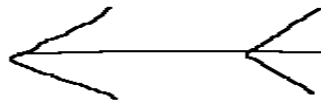
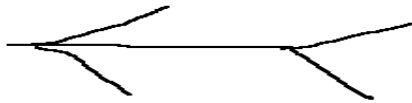

SUBTEST NO. 16		SPATIAL REVERSAL
Purpose	To assess one's ability to spatially reverse an object from the way that it was presented.	
Administration Instructions	Point to the arrow . "NOW I WANT YOU TO DRAW ANOTHER ONE LIKE THIS, BUT THIS TIME POINTING THE OPPOSITE WAY" Avoid indicating direction.	
Scoring Procedure	5 Points - arrow must be in opposite direction - Horizontal axis rotated less than 15 degrees. Use Figure H-a. Place left edge of drawing parallel to left edge of template so that left vertex is on point 'C'. 'Shaft' of arrow should be between the lines marked 'b';	
Maximum Total Score	5	
Interpretation	Inability to reverse a figure is an indication of at least moderate spatial dysfunction.	
Acceptable Answers	see examples below	

Template: - Figure H - a

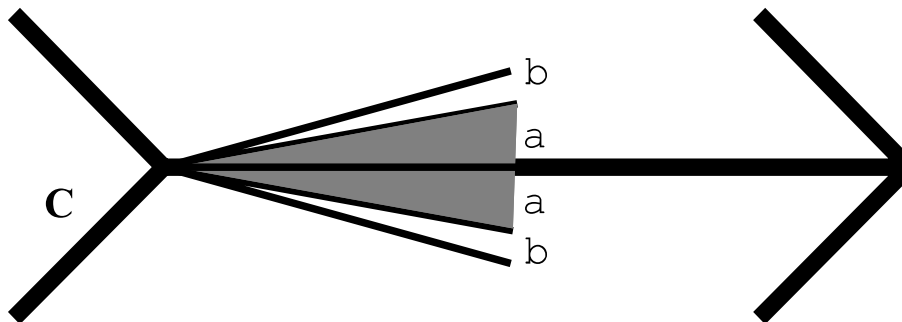

Examples:

0 Points

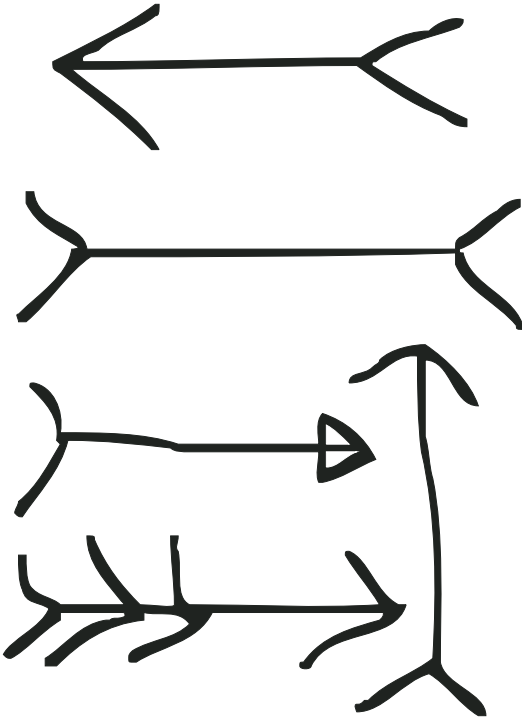

5 Points

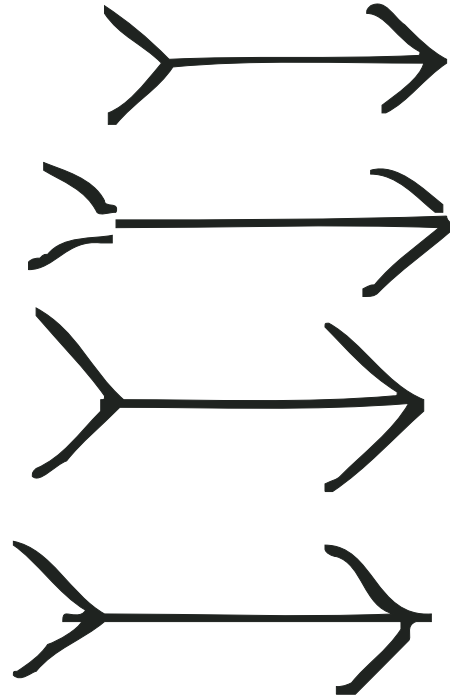



SUBTEST NO. 17		IDEOMOTOR
Purpose	Another visual-motor function test which requires one to conceptualize a purposeful action without the benefit of the associated objects.	
Administration Instructions	Ask each question as written. 1. "SHOW ME HOW YOU WOULD STIR A CUP OF TEA" 2. "SHOW ME HOW YOU WOULD HAMMER A NAIL" 3. "SHOW ME HOW YOU WOULD BLOW OUT A CANDLE"	
Scoring Procedure	Patient must be able to make a reasonable motor action that is easily interpretable as required behaviour. 1 Point for each correct response.	
Maximum Total Score	3	
Interpretation	Poor performance on this task is more commonly associated with more advanced dementias, or other organic brain syndromes (such as strokes) that disrupt over-learned motor responses.	

SUBTEST NO. 18		CLOCK DRAWING
Purpose	Clock drawing is another test of visual-motor functioning.	
Maximum Total Score	7	
Interpretation	Clock drawing is a sensitive measure of visual-motor function, and problems with this task are often seen as an early sign of dementia.	
a) NUMBERS [1st blank - circle] Administration Instructions	<p>"I WANT YOU TO WRITE IN THE NUMBERS, AS ON A CLOCK FACE" If patient writes only some of the numbers, e.g. 3,6,9,12, say, "PLEASE, WRITE ALL OF THE NUMBERS" Make sure that the top of the clock (i.e. the 12), is at the top of the page. If not, mark top (i.e. patient's top).</p>	
Scoring Procedure	<p>USE FIGURE I and examples on page 35.</p> <p>2 Points - numbers 1 - 12 (and no extra numbers) fairly straight and nearly evenly spaced around periphery, with the 12 at the top. When the reproduction is placed over Figure I with the 12 placed at the top of vertical line (L L'), the major part of the 3, 6 and 9 should be in the appropriate areas marked 'a';</p> <ul style="list-style-type: none"> - main bodies of <u>ALL</u> numbers should be within the outer ring marked 'b'; - not more than one number rotated 90 degrees or more <p>1 Point - some distortion in spacing of numbers is acceptable, i.e., when reproduction is placed over Figure I, so that the 12 lies on the vertical line (L L'), the major part of any <u>2</u> of the numbers 3, 6 and 9 should be in the appropriate areas marked 'a';</p> <ul style="list-style-type: none"> - main bodies of all but <u>1</u> of the numbers should be within the outer ring 'b'; - no extra numbers can be included 	
Maximum Score	2	



SUBTEST NO. 18		CLOCK DRAWING
b) 9:00 [2nd blank - circle] Administration Instructions	"ON THIS CIRCLE DRAW IN THE HANDS TO MAKE IT SAY 9 O'CLOCK."	
Scoring Procedure	USE FIGURE J and examples on page 36. 2 Points <ul style="list-style-type: none">- using Figure J, the vertex should be centred within the area marked 'a', the 'hands' should fall in the tracks marked 'b'.- 'hands' should be connected (or almost connected) at an approximate right angle;- hour 'hand' SHORTER than minute 'hand'. 1 Point <ul style="list-style-type: none">- connecting point of 'hands' off-centre but within the larger central circle marked 'c';- hour 'hand' NOT LONGER than minute hand;- if 'hands' are not connected, both should radiate from larger central area marked 'c'	
Maximum Score	2	
c) 10:05 [3rd circle - numbered] Administration Instructions	"NOW TRY THIS ONE. PUT IN THE HANDS FOR 5 PAST 10. MAKE IT SAY 5 PAST 10"	
Scoring Procedure	<ul style="list-style-type: none">- follow scoring guidelines for 9:00 o'clock. See examples on page 37.- place 10:05 clock face over Figure J, and rotate it so that numbers 10 and 1 are inside the shaded areas marked 'a';	
Maximum Score	2	
d) 8:20 [4th circle - numbered and hands] Administration Instructions	Say , "WHAT TIME IS IT ON THIS CLOCK?"	
Scoring Procedure	1 point for 8:20 (or 20 past 8)	
Maximum Score	1	

Template: - Figure I

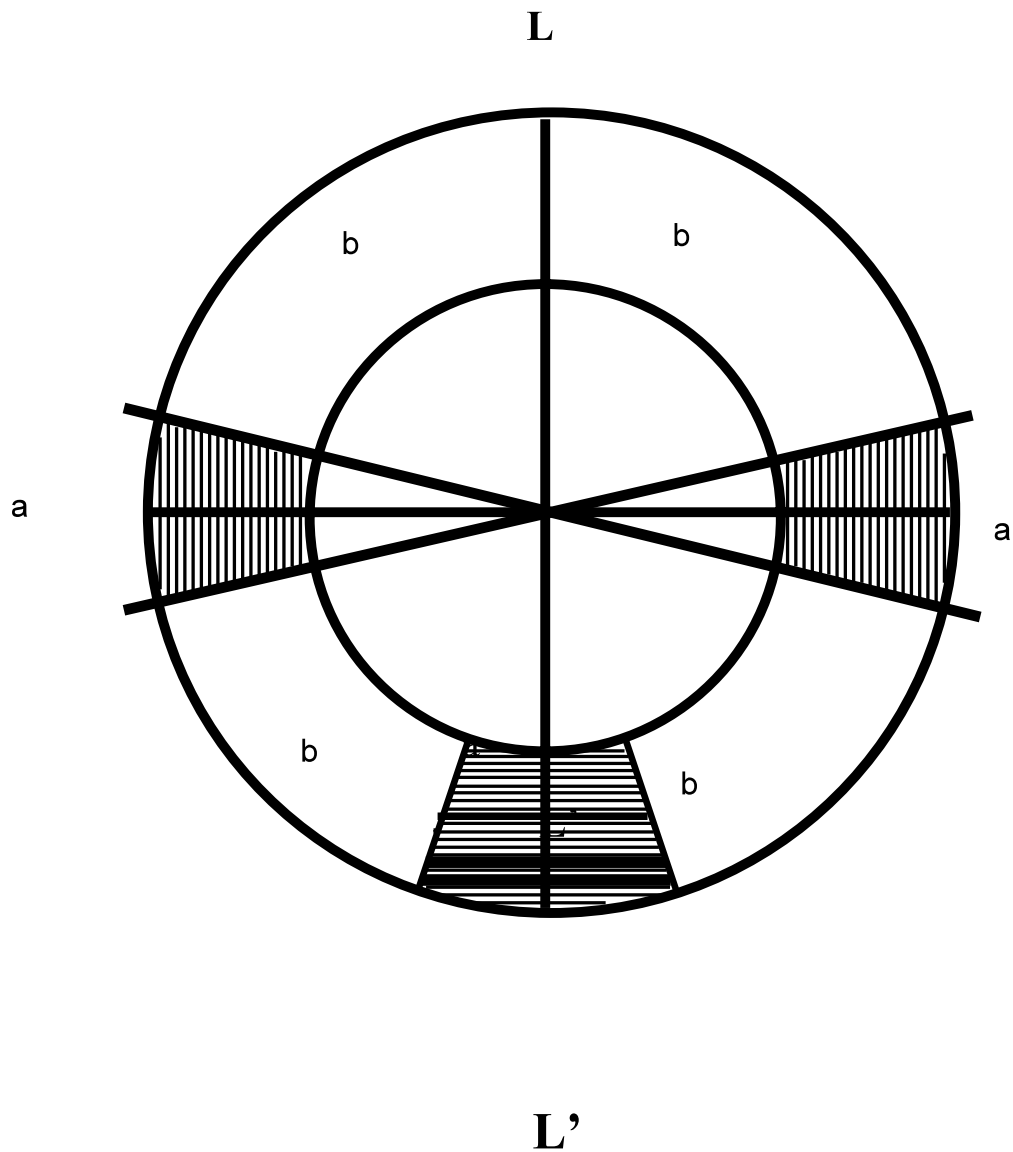
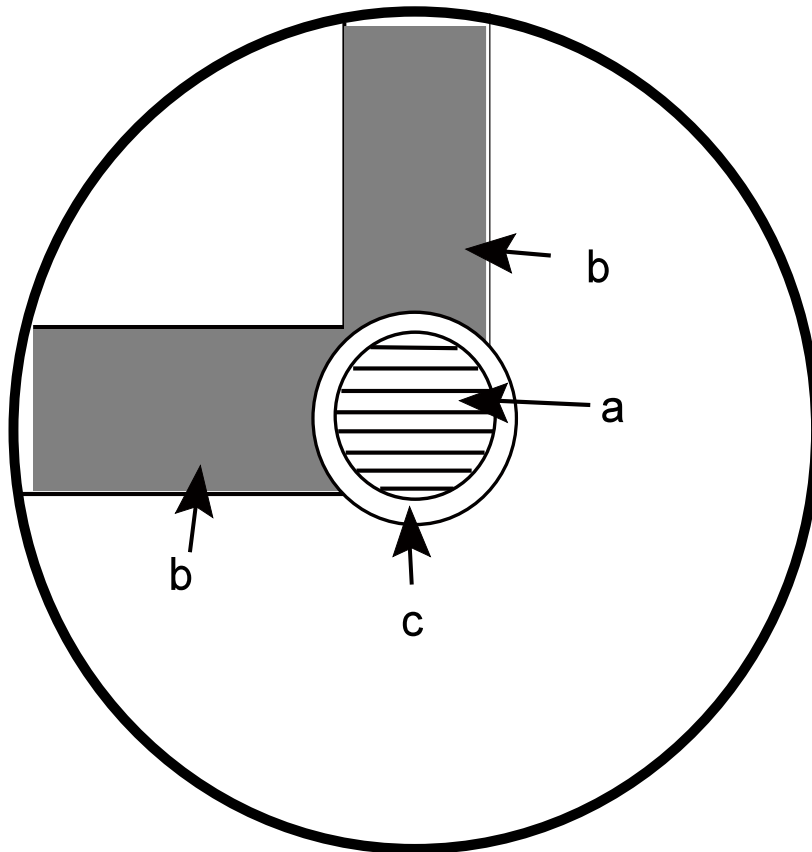

Figure J



Examples: -

Numbers:

2 Points

1 Point

0 Points

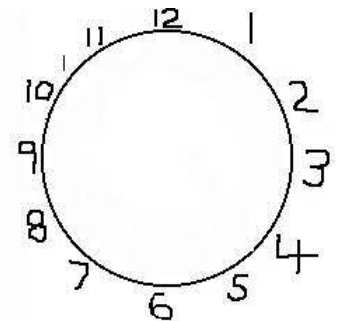
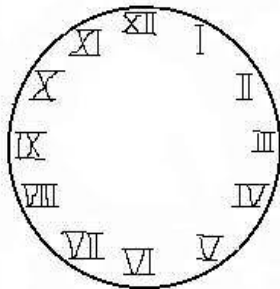
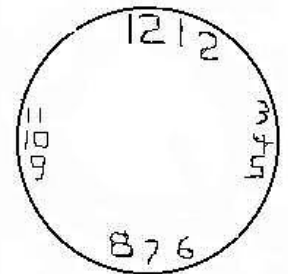
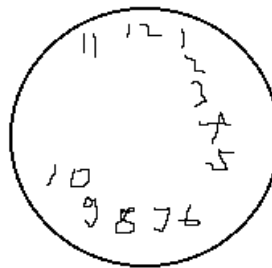
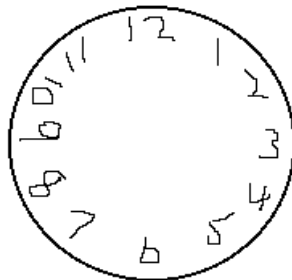
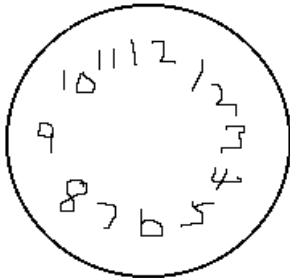
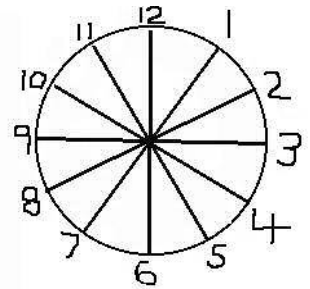
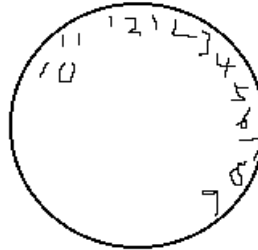
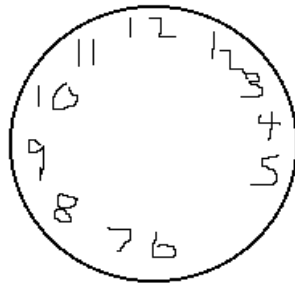
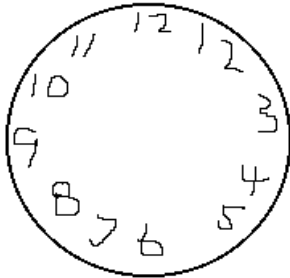

9:00:

2 Points

1 Point

0 Points

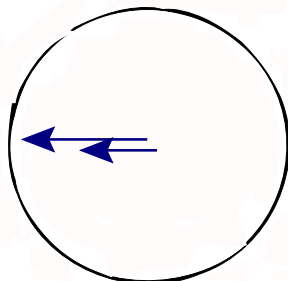
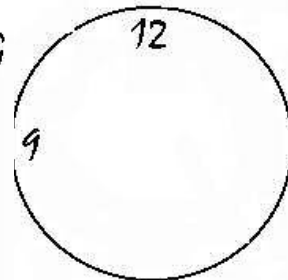
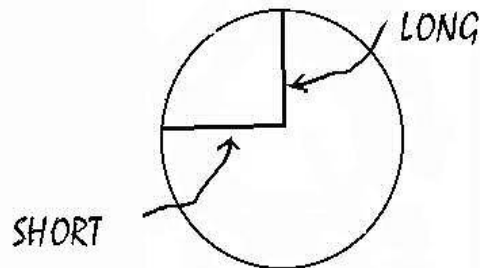
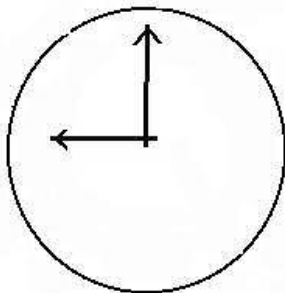
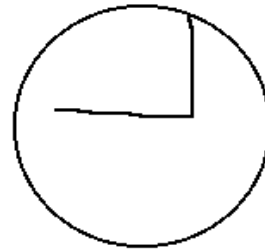
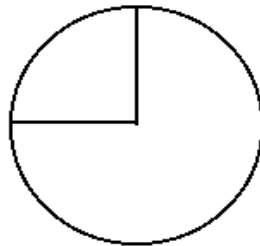
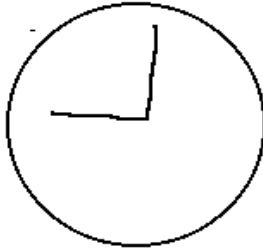
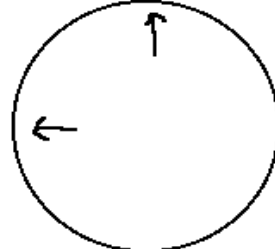
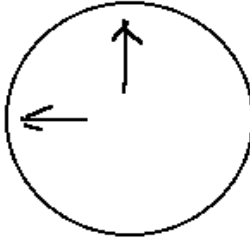
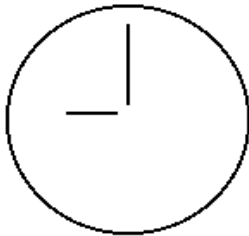
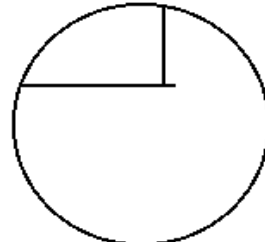
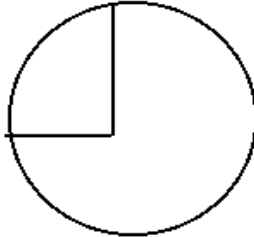
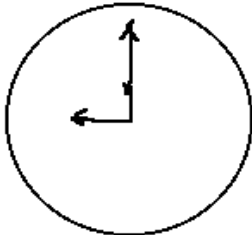

10:05:

2 Points

1 Point

0 Points

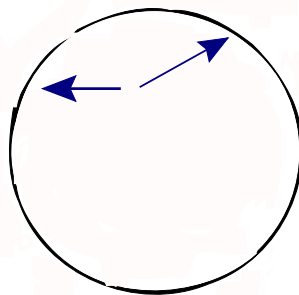
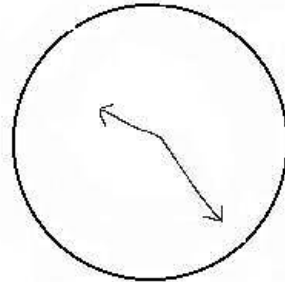
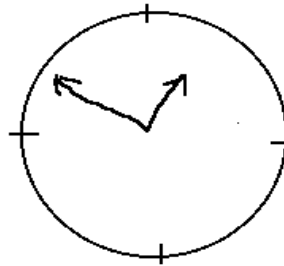
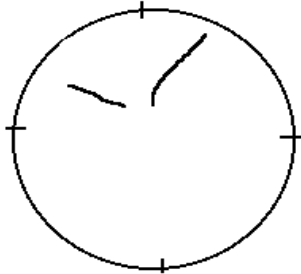
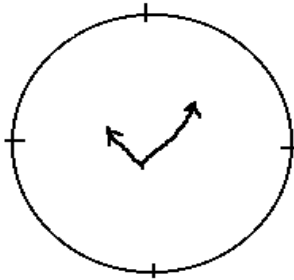
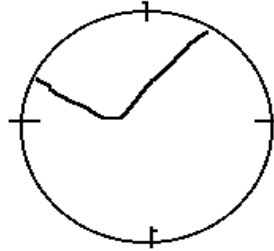
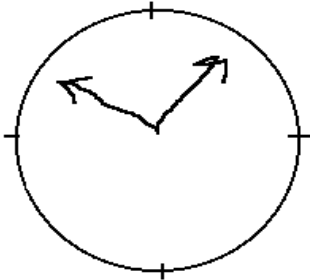
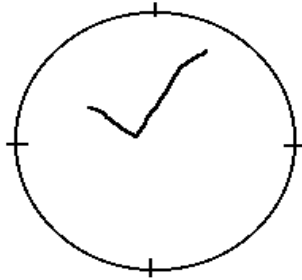



SUBTEST NO. 19	PERSEVERATION
Purpose	To assess one's ability to perform several complex repetitive motor tasks without repeating parts of the task out of sequence.
Administration Instructions a) Motor Pattern	Demonstrate touching table alternately first with palm of hand and then with fist on edge, i.e., thumb facing up. Movements should be alternated at a rate of not faster than one movement per ½ second and no slower than one movement per second. Have the patient copy your motions for 5 trials or until you are sure that the patient has learned the pattern. If patient is unable to learn the task within 10 trials, discontinue and score 0. If patient has successfully learned the task, say: "I WANT YOU TO REPEAT THIS MOVEMENT ON YOUR OWN UNTIL I SAY 'STOP'." If their response degrades before 5 repetitions, say "STOP" . Otherwise let him/her do at least five repetitions using his/her preferred hand.
Scoring Procedure	1 Point - if patient is able to complete at least 5 repetitions on his/her own, without any alternation errors.
Administration Instructions b) Visual Pattern	"I WANT YOU TO COPY THIS PATTERN. START COPYING BELOW THE EXAMPLE, AND THEN CONTINUE IT TO THE END OF THE PAGE. START HERE..." (Pointing to the correct position.) Encourage patient to continue to right margin of page.
Scoring Procedure	1 Point for any reasonable copy; rectangular and pointed shapes should be clearly distinguished; Should have 3 points and 3 rectangles approximately under stimulus.
Maximum Total Score	2
Interpretation	Problems with these tasks are usually indicative of an inability to switch cognitive sets, and is associated with frontal lobe dysfunction.

Examples: -

1 Point

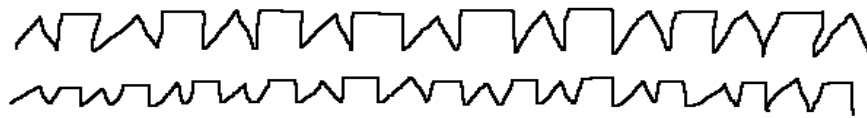

0 Points

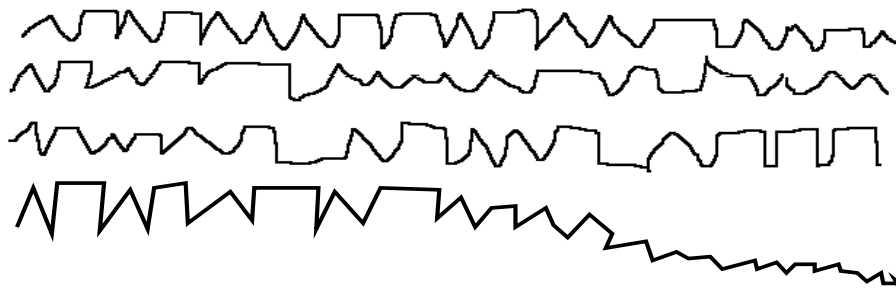

Instructions for OBSERVATIONS DURING EXAMINATION	
Purpose	These short scales allow the clinician to rate certain behaviours observed during the assessment procedure.
Administration Instructions	This section is used to rate patient behaviour during the examination. Items a and b are rated from 1 to 5. A normal rating is 3 and values above or below 3 indicate the degree of deviation from normal. Items c to j are rated from 1 to 3. A normal rating is 1, and 2 or 3 indicate the degree of deviation from normal.
Scoring Procedure	Although this is not part of the total score, it is an important part of creating an impression of the individual's presentation and a valuable aspect of the overall clinical picture.

BEHAVIOUR AT TIME OF EXAMINATION

- a] OVERLY PERSISTENT 1 2 **3** 4 5 GIVES UP EASILY
 - Did the patient work persistently and refuse to give up on tasks, or did he/she stop as soon as he/she encountered any difficulty or frustration?
- b] UNCONCERNED 1 2 **3** 4 5 ANXIOUS
 - Did the patient show any undue anxiety about the examination, or did he/she act as if he/she was completely unconcerned?
- c] RELAXED **1** 2 3 RESTLESS
 - Was the patient relaxed, at ease with the examination or was he/she restless, having difficulty attending to tasks because of it?
- d] FULLY ALERT **1** 2 3 DEPRESSED LEVEL OF CONSCIOUSNESS
 - Was the patient fully alert or was his/her level of consciousness decreased?
- e] GOOD CONCENTRATION **1** 2 3 EASILY DISTRACTED
 - Was the patient able to concentrate on the tasks without too much difficulty, or was he/she easily distracted and have difficulty concentrating?
- f] COOPERATIVE **1** 2 3 UNCOOPERATIVE
 - Was the patient cooperative to the examination procedures or was he/she less than willing to participate?

LANGUAGE USAGE

g] ARTICULATION GOOD **1** 2 3 ARTICULATION POOR

- Was the patient's articulation good, or did he/she have difficulty pronouncing words (either common or uncommon)?

h] SPONTANEOUS SPEECH **1** 2 3 SPEAKS ONLY WHEN
SPOKEN TO

- Did the patient speak spontaneously to a normal degree or was he/she reluctant to speak?

i] FLUENT SPEECH **1** 2 3 NON FLUENT SPEECH

- Was the patient able to speak fluently, without obvious breaks or periods where he/she was searching for words?

j] NORMAL SPEECH **1** 2 3 PERSEVERATIVE SPEECH

- Did the patient display a number of perseverative behaviours in his/her speech, such as repeating words or phrases over and over again? Was there repetition of ideas or responses, such as giving the same specific response (versus a general response such as "I don't know") to different questions?

KSCAr SCORE ANALYSIS PAGES

This section of the KSCAr is designed to make the analysis of the scores easier and more meaningful. To aid in this, the KSCAr scores are translated into **percentiles** which make the scores more easily compared across patients. Percentiles are a simple way of describing how a person did relative to a larger group of other people on a particular task. If there were a number of different people being compared on a test, their performances would vary; some would do poorly and others would do very well. These scores could then be ranked from lowest to highest. Percentiles do this using a scale of 1 to 100. Someone with an excellent score would have more people who did worse than them, and fewer who did better, so their ranking would be higher (e.g.. the 90th percentile). Conversely, someone who did poorly on that test would be ranked lower, as more people were able to do better (e.g.. the 20th percentile). If someone has a score at the 70th percentile, it can be said that he or she performed as well or better than 70 percent of the people that have taken the test. If you were a person with a score that was right in the middle, you'd be ranked at the 50th percentile, meaning there were as many people who did better than you on that test as there were people who did worse than you. In general, percentiles make interpreting performance easier, as scores are always converted to a scale of 1 to 100.

After a patient has completed a KSCAr and you have scored all the sub-tests, tally the scores on the "Scoring Summary" (page 37), then, use the "Score Analysis Pages" (38-40) and follow the steps as outlined below in order to calculate the percentiles and determine the patient's level of performance.

STEP 1: MAKE AN ESTIMATION OF THE LEVEL THAT THE PATIENT FUNCTIONED AT PRIOR TO HIS OR HER CURRENT ILLNESS (or condition that resulted in this assessment).

This is called the **premorbid** level of functioning.

Did the individual have more than average education (or less)? Did the individual have a number of hobbies? More education, and more hobbies or interests usually indicate higher levels of functioning. How do family and friends regard the individual? Do they describe the individual as "smart", "very bright" or "clever", or the opposite, or "average". Remember that most people will fall into the "average" range unless, you have some clear evidence such as suggested above, that they functioned above or below it.

STEP 2: USING THE "SCORE ANALYSIS PAGE 1" (Assessment Form Page 38), LOCATE THE CHART LABELLED "NORMALS" AND CIRCLE THE PATIENT'S TOTAL SCORE (left hand column). READ THE CORRESPONDING PERCENTILE FROM THE MIDDLE COLUMN. THE THIRD COLUMN, (i.e. right hand column), WILL SHOW WHAT RANGE THE TOTAL SCORE FALLS IN. (See Note 1.)

STEP 3: IS THE PATIENT'S SCORE IN OR ABOVE THE RANGE (Premorbid Estimate) THAT YOU ESTABLISHED IN STEP 1? IF SO, NO FURTHER ANALYSIS IS REQUIRED. THE PATIENT IS NOT LIKELY SHOWING ANY MEASURABLE DECLINE FROM PREVIOUS LEVELS. THEREFORE, SIGNIFICANT DEMENTIA IS UNLIKELY.

ON THE OTHER HAND, IF THE PATIENT'S CURRENT LEVEL OF FUNCTIONING IS BELOW YOUR ESTIMATED PREMORBID LEVEL, MOVE ON TO STEP 4. (See Note 2.)

STEP 4: NOW COMPARE THE PATIENT'S TOTAL SCORE TO THE 'DEMENTIA' DISTRIBUTION USING "SCORE ANALYSIS PAGE 2" (Page 39), OBTAINING BOTH THE PERCENTILE AND DESCRIPTIVE RANGE FOR THAT SCORE.

STEP 5: USING THE 3 SUB-TOTAL SCORES FOR MEMORY, LANGUAGE, AND VISUAL-MOTOR, OBTAIN THE PERCENTILES AND DESCRIPTIONS FROM "SCORE ANALYSIS PAGE 3" (Page 40). (Also see Notes 3, 4 and 5.)

NOTES:

- 1 **What do I do first?** - The KSCAr is designed to compare an individual's performance to a large number of other people who have already taken the test. In fact, it is used to compare two different groups: healthy NORMAL elderly people living in the community, and people with identified DEMENTIA. The first comparison is always with the NORMALS.

- 2 **Is there a problem?** - Remember, it is from this analysis that one determines whether or not the individual is likely suffering from a dementia. It is also sometimes a good idea to check the 3 Normal Sub-Total scores for Memory, Language, and Visual-Motor, and obtain the percentiles. While this information is not found in the "Assessment Form" it is found in this manual (page 46). These Sub-Total scores should also fall within your premorbid estimate.

Why are some percentiles so low? - Here, however, one can get somewhat confused, as the percentiles for Sub-Total scores for Normals (page 46 of this manual) may seem rather low. For example, if one scores 30/31 on the Visual-Motor section, you will find that the percentile is only at 8.5. This is caused by the fact that over 83 % of the individuals comprising the Normal sample scored a perfect score of 31. Consequently, a score of only 1 point lower results in a performance below the 10th percentile level. Also, the perfect score of 31 is said to be at the 17th percentile. Actually, it covers the whole range from 17 to 100, but because one cannot say that one person's perfect score is better than someone else's, all are said to be at the bottom of the range, i.e. the 17th percentile. See note 6.

- 3 **Different charts, different values?** - It should be noted that the percentile conversion charts for each group in the back of this manual and the "Total Score Percentiles" chart on page 44 (of this manual) are set up differently. The chart on page 44 is divided up into intervals of every 5 percentile points (e.g. 30th, 35th, 40th etc.) with the scores calculated to fit them. This often produces scores that are not possible to actually obtain, but are mathematically correct (e.g. 109.3, 110.8). On the other hand, the group charts in the back of this manual use actual scores (e.g. 109, 110, 111 ...) with the corresponding percentiles calculated to fit, and often appear as fractions (e.g. 32.2, 44.1, 54.2...). Quoting percentiles as decimal fractions is mathematically acceptable. In the Assessment Form Score Analysis Pages (38-40) a combination of these styles are used. Only obtainable scores with their approximate percentiles are given for roughly every 5 percentile points.

- 4 **What if a score falls between two percentiles?** - If the score falls between two percentiles (e.g. a total score of 109 falls between the 30th and 35th percentiles for normals), one can say that the score is at "approximately the 32nd percentile", or falls "just below the 35th percentile", or "just above the 30th percentile".

Can one get half scores? - It should also be noted that due to Word Recognition, half scores are often possible. For brevity, only some are shown in the percentile conversion charts.

- 5 **Can I use raw scores?** - It is most important to use only **percentiles** (or descriptive ranges) in the discussion and comparison of patients assessed by the KSCAr. **Raw scores have no particular meaning and are not directly interpretable, they are used only to calculate the percentiles.**

- 6 **My patient couldn't complete all of the subtests. Can I still get any useable information from the KSCAr?** - In clinical practice, this situation can arise with individuals who have significantly impaired vision, such as in cases of advanced cataracts or Macular Degeneration; it can also occur if the person doesn't have sufficient motor control to use a pencil. Alternatively, in very rare cases, a patient may discontinue the test before its completion. In these cases, you can still use the information from any of the subtests that were completely administered. Simply look up the sub-test percentile values that are provided in the manual. You can then comment on where the person is functioning within that sub-test with respect to the percentiles. If you feel that additional testing data are needed, a referral for neuropsychological testing would be appropriate.

- 7 At this point, a cautionary note about sub-test percentiles is warranted. As mentioned above in note 2, percentiles, where the range of possible values is limited, often appear very low, and this is especially true in the case of sub-test scores. Again, it has to be remembered that even with a perfect score (e.g. 10 out of 10) the given percentile may be very low (e.g. 6.1). This seemingly strange result arises when, in this example, 93.9% of the sample all scored 10. Therefore, the percentile range is really from 6.1 to 100, but by convention the lower value is used. However, it must be remembered that the true percentile position could be considered 100. A score of one point less (i.e. 9 out of 10) may be listed as at the 2nd percentile. Meaning that it actually has a range from as low as the 2nd and as high as to the 6th percentile.

MAXIMUM SCORES**SUB-TESTS**

ORIENTATION	10
DIGITS FORWARD	5
DIGITS BACKWARDS	4
WORD RECALL	10
VISUAL MEMORY	6
WORD FINDING	10
READING COMPREHENSION	3
ABSTRACT	8
CALCULATION	4
WRITING	4
RIGHT-LEFT ORIENTATION	10
VERBAL COMPREHENSION	10
DELAYED WORD RECALL	10
WORD RECOGNITION	10
COPYING	4
SPATIAL REVERSAL	5
IDEOMOTOR	3
CLOCK	7
PERSEVERATION	2
TOTAL SCORE	125

SUB-TOTALS

LANGUAGE	39
VISUAL-MOTOR	31
MEMORY	55

TOTAL SCORE - PERCENTILES

DEMENTIA

TOTAL SCORE	<i>PERCENTILE</i>
62	5
72.5	10
76	15
77	20
79	25
82	30
83	35
85	40
87.5	45
89.5	50
91	55
93	60
94	65
95	70
97	75
98.5	80
100	85
102.5	90
105	95

NORMALS

TOTAL SCORE	<i>PERCENTILE</i>
105	5
106	10
107	15
108	20
108.3	25
108.8	30
109.3	35
109.8	40
110	45
110.8	50
111	55
111.5	60
112.3	65
112.5	70
113	75
114	80
114.8	85
116.5	90
118	95

NORMAL GROUP

	MEAN	STD DEV	STD ERR	MIN	MAX
AGE OF SUBJECT	72.58	8.21	2.13	62	92
YEARS OF EDUCATION	12.42	3.13	0.70	4	19
ORIENTATION	9.98	0.13	0.03	9	10
WORD RECALL	5.32	1.50	0.36	2	9
DELAYED RECALL	4.07	1.76	0.44	0	9
WORD RECOGNITION	8.45	1.11	0.26	5	10
VISUAL MEMORY	5.12	1.06	0.26	2	6
DIGITS FORWARD	4.95	0.22	0.05	4	5
DIGITS BACKWARD	3.62	0.69	0.17	1	4
WORD FINDING	10.00	0	0	10	10
READING COMPREHENSION	2.95	0.22	0.05	2	3
WRITING	4.00	0	0	4	4
VERBAL COMPREHENSION	10.00	0	0	10	10
ABSTRACT REASONING	7.82	0.39	0.10	7	8
CALCULATION	3.93	0.25	0.06	3	4
RIGHT-LEFT ORIENTATION	9.98	0.13	0.03	9	10
COPYING TASK	4.00	0	0	4	4
SPATIAL REVERSAL	5.00	0	0	5	5
IDEOMOTOR	3.00	0	0	3	3
CLOCK TEST	6.72	0.87	0.22	2	7
PERSEVERATION	1.98	0.13	0.03	1	2
TOTAL SCORE	110.88	4.28	1.07	102.5	123
SUB TOTALS					
LANGUAGE	38.70	0.59	0.15	37	39
VISUAL-MOTOR	30.68	0.87	0.22	26	31
MEMORY	41.50	4.06	1.02	32.5	53

n = 60

NORMAL CONTROLS - PERCENTILES
TOTAL SCORE

SCORE	PERCENTILE	SCORE	PERCENTILE
104	1.7	112	61
105	5.1	113	74.6
106	11.9	114	79.7
107	13.6	115	86.4
108	20.3	116	88.1
109	32.2	117	91.5
110	44.1	118	94.9
111	54.2	123	98.3

MEMORY

SCORE	PERCENTILE	SCORE	PERCENTILE
35	1.7	43	71.2
36	5.1	43.5	78
37	8.5	44	79.7
38	15.3	44.5	81.4
38.5	22	45	84.8
39	25.4	46	86.4
40	35.6	46.5	88.1
40.5	39	47	89.8
41	45.8	47.5	91.5
41.5	47.5	48	93.2
42	52.5	48.5	96.6
42.5	66.1	53	98.3

LANGUAGE

SCORE	PERCENTILE
38	6.8
39	23.7

VISUAL-MOTOR

SCORE	PERCENTILE
28	1.78
29	3.4
30	8.5
31	17

DEMENTIA - ALZHEIMER'S DISEASE GROUP *

	MEAN	STD DEV	STD ERR	MIN	MAX
AGE OF SUBJECT	78.55	6.03	0.93	58	90
YEARS OF EDUCATION	11.37	3.21	0.50	3	20
DURATION OF ILLNESS	2.33	2.04	0.31	0	10
ORIENTATION	8.16	2.21	0.34	2	10
WORD RECALL	2.47	1.62	0.25	0	7
DELAYED RECALL	0.69	1.08	0.17	0	4
WORD RECOGNITION	6.39	2.03	0.31	0	10
VISUAL MEMORY	2.89	1.60	0.25	0	6
DIGITS FORWARD	4.50	0.83	0.13	2	5
DIGITS BACKWARD	2.76	1.06	0.16	0	4
WORD FINDING	9.42	1.10	0.17	4	10
READING COMPREHENSION	2.77	0.62	0.10	0	3
WRITING	3.84	0.58	0.09	1	4
VERBAL COMPREHENSION	9.86	0.84	0.13	2	10
ABSTRACT REASONING	5.86	2.34	0.36	0	8
CALCULATION	3.31	0.95	0.15	1	4
RIGHT-LEFT ORIENTATION	9.73	0.75	0.12	7	10
COPYING TASK	3.53	0.93	0.14	0	4
SPATIAL REVERSAL	2.75	2.50	0.39	0	5
IDEOMOTOR	2.92	0.39	0.06	0	3
CLOCK TEST	3.59	2.38	0.37	0	7
PERSEVERATION	1.49	0.67	0.10	0	2
TOTAL SCORE	87.02	13.61	2.10	34	107
SUB TOTALS					
LANGUAGE	35.06	4.57	0.71	13	39
VISUAL-MOTOR	24.10	5.53	0.85	10	31
MEMORY	27.86	6.10	0.94	10	42

n = 100

* THIS IS THE 'DEMENTIA' GROUP USED IN THE ASSESSMENT FORM SCORE ANALYSIS PAGES

DEMENTIA - ALZHEIMER'S DISEASE GROUP - PERCENTILES
TOTAL SCORE

SCORE	PERCENTILE	SCORE	PERCENTILE	SCORE	PERCENTILE
41	1	81	28.3	94.5	67.7
59	2	82	30.3	95	69.7
59.5	4	82.5	33.3	95.5	71.7
62	5.1	83	34.3	96	72.7
63.5	6.1	83.5	36.4	97	73.7
66.5	7.1	85	39.4	98	77.8
69	8.1	86	41.4	98.5	79.8
69.5	9.1	86.5	42.4	99	80.8
72.5	10.1	87.5	45.5	100	83.8
74.5	11.1	88	46.5	101.5	86.9
75	12.1	89	49.5	102.5	89.9
75.5	13.1	89.5	50.5	103	90.9
76	15.2	90	51.5	103.5	91.9
76.5	17.2	91	53.5	104	93.9
77	20.2	91.5	56.6	105	95
78	21.2	92	58.6	105.5	96
78.5	24.2	93	60.6	106	98
79.5	25.3	93.5	62.6	106.5	99
80	26.3	94	64.7		

MEMORY

SCORE	PERCENTILE	SCORE	PERCENTILE	SCORE	PERCENTILE
12	1	24	23.2	32.5	74.5
14	2	25	26.3	33	76.8
15.5	3	25.5	34.3	33.5	79.8
17	4	26	39.4	34	82.8
18.5	5.1	26.5	43.4	34.5	83.8
19	6.1	27	45.5	35	85.9
20	7.1	27.5	51.5	35.5	88.9
20.5	8.1	28	55.6	36	91.9
21	10.1	29	58.6	36.5	93.9
21.5	11.1	30	59.6	37	96
22	15.2	30.5	61.6	37.5	97
22.5	16.2	31	63.6	38	98
23	18.2	31.5	66.7	39.5	99
23.5	21.2	32	67.7		

**LANGUAGE**

SCORE	PERCENTILE	SCORE	PERCENTILE	SCORE	PERCENTILE
14	1	30	7.1	36	42.4
24	2	31	8.1	37	50.5
26	3	32	15.2	38	64.7
27	4	33	23.2	39	77.8
28	5.1	34	30.3		
29	6.1	35	36.4		

VISUAL-MOTOR

SCORE	PERCENTILE	SCORE	PERCENTILE	SCORE	PERCENTILE
11	1	19	15.2	26	58.6
12	3	20	23.2	27	61.6
14	4	21	29.3	28	65.7
15	5.1	22	36.4	29	67.7
16	6.1	23	37.4	30	78.8
17	9.1	24	42.4	31	85.9
18	12.1	25	50.51		

SUB-TEST SCORE PERCENTILES FOR ALZHEIMER'S GROUP *

SCORE	%ile	SCORE	%ile	SCORE	%ile
Orientation		Word Finding		Verbal Comprehension	
10	63	10	30	10	6.1
9	37	9	15	9	2
8	29	8	9.1	8	1
7	23	7	2		
6	18	6	1		
5	9.1				
4	5.1				
3	1				
Spatial Reversal		Calculation		Copying	
5	46	4	43	4	19
		3	18	3	10
		2	8.1	2	6.1
				1	3
Perseveration		Abstract Thinking		Clock Drawing	
2	41	8	60	7	84
1	10	7	53	6	73
		6	38	5	60
		5	24	4	54
Reading Comprehension		4	22	3	38
3	16	3	12	2	26
2	4	2	4	1	10
1	3	1	3		



SCORE	%ile	SCORE	%ile	SCORE	%ile
Visual Memory		R L Orientation		Writing	
6	94	10	14	4	9.1
5	83	9	8.1	3	4
4	69	8	5.1	2	3
3	42				
2	19				
1	7.1				
Word Recall		Delayed Recall		Word Recognition	
7	99	4	98	10	99
6	96	3	93	9	92
5	90	2	79	8	76
4	79	1	65	7	54
3	55			6	36
2	28			5	10
1	11			4	5.1
Ideomotor		Digits Forward		Digits Backward	
3	5.1	5	32	4	73
2	2	4	14	3	37
1	1	3	4	2	11
				1	4

* See note 7 on page 45.

KSCAr Norms by Education ALZHEIMER'S GROUP

	Elementary School (Gr 1 - 8)		High School (Gr 9 -12)		Post Secondary	
	Mean	sd	Mean	sd	Mean	sd
Years of Education	7.23	1.41	11.14	1.08	15.45	1.91
Age	80.29	5.39	78.42	5.78	78.36	5.65
Years of Illness	2.27	2.41	2.84	1.92	2.77	1.79
n	31		50		40	
Males	9		16		24	
Females	22		34		16	
Orientation	8.06	2.08	8.02	2.31	8.73	9.96
Word Recall	2.39	1.54	2.76	1.59	2.8	1.81
Delayed Recall	0.65	1.08	0.8	1.06	0.83	1.26
Word Recognition	6.16	2.1	6.71	1.83	6.54	1.66
Visual Memory	2.71	1.57	3	1.71	4.05	1.22
Digits For ward	3.65	1.31	4.34	0.95	4.38	0.8
Digits Backward	2.35	1.45	3.12	1.18	3.33	1.19
Memory Sub Total /55	25.97	6.86	28.75	6.22	30.44	5.22
Word Finding	9.03	1.47	9.5	1	9.68	0.88
Reading	2.58	0.92	2.88	0.38	2.88	0.33
Writing	3.58	0.92	3.94	0.31	3.95	0.22
Verbal Comprehension	9.65	1.47	9.98	0.14	9.93	0.26
Abstract Thinking	4.68	2.8	6.14	2.08	6.9	1.76
Calculation	2.48	1.15	3.62	0.56	3.68	0.57
Language Sub Ttl /39	32	6.33	36.06	3.07	37	2.82
Right/Left Orientation	9.48	1.06	9.74	0.8	9.85	0.42
Copying	3.52	0.89	3.54	1.19	3.83	0.54
Spatial Reversal	1.77	2.43	3	2.45	3.5	2.29
Ideomotor	2.84	0.64	2.98	0.14	2.95	0.22
Clock Drawing	1.9	1.49	3.84	2.41	4.78	2.13
Perseveration	1.26	0.73	1.54	0.57	1.55	0.71
Spatial Sub Total /31	20.77	4.63	24.64	5.87	26.45	4.84
Total /125	78.74	15.47	89.45	12.65	93.89	10.63
Minimum Score	34		59		56.5	
Maximum Score	110		109		109	
BriefKSCA SCORE	26.87	8.62	32.81	8.94	35.41	7.85

SCORE TO PERCENTILE CONVERSIONS
ELEMENTARY SCHOOL ALZHEIMER'S GROUP
TOTAL SCORE

SCORE	PERCENTILE	SCORE	PERCENTILE	SCORE	PERCENTILE
101	99.7	83.5	60	74.5	23.3
98.5	93.3	82	53.3	69.5	20
94	90	81	48.7	69	16.7
89.5	86.7	79	43.3	63.5	13.3
88	83.3	78	36.7	62	10
86.5	76.7	77	33.3	59	8.7
86	70	76.5	30	41	3.3
85	66.7	76	26.7		

MEMORY

SCORE	PERCENTILE	SCORE	PERCENTILE
36	93.3	26	46.7
35.5	90	25	33.3
32.5	86.7	24	26.7
32	83.3	23.5	23.3
31.5	80	22.5	20
28.5	76.7	22	16.7
28	73.3	21.5	13.3
27.5	70	17	10
27	63.3	14	6.7
26.5	56.7	12	3.3

LANGUAGE

SCORE	PERCENTILE	SCORE	PERCENTILE
39	93.3	31	23.3
38	80	30	20
37	73.3	28	16.7
35	66.7	27	13.3
34	63.3	26	10
33	50	24	6.7
32	40	14	3.3



VISUAL-MOTOR

SCORE	PERCENTILE	SCORE	PERCENTILE
27	93.3	20	50
26	86.7	19	26.7
25	70	18	23.3
24	66.7	17	16.7
23	63.3	16	6.7
21	53.3	11	3.3



SUB-TEST SCORE PERCENTILES FOR ELEMENTARY SCHOOL GROUP *

SCORE	%ile	SCORE	%ile	SCORE	%ile
Orientation		Word Finding		Verbal Comprehension	
1	76.7	10	43	10	10
9	40	9	27	9	6.7
8	30	8	20	8	3.3
7	20	7	3.3		
5	10				
4	3.3				
Spatial Reversal		Calculation		Copying	
5	67	4	77	4	30
		3	53	3	13
		2	27	2	6.7
Perseveration		Abstract Thinking		Clock Drawing	
2	60	4	77	5	97
1	17	7	67	4	90
		6	57	3	70
		5	47	2	53
Reading Comprehension					
3	23	4	43	1	13
2	10	3	33		
		2	10		

* See note 7 on page 45.



SCORE	%ile	SCORE	%ile	SCORE	%ile
Visual Memory		R L Orientation		Writing	
5	83.3	10	23.3	4	23
4	76.7	9	16.7	3	10
3	50	8	13.3		
2	23.3				
1	6.7				
Word Recall		Delayed Recall		Word Recognition	
5	93.3	3	90	8.5	93.3
4	90	2	83.3	8	80
3	56.7	1	70	7.5	70
2	23.3			7	53.3
1	13.3			6.5	46.7
				6	36.7
				5.5	30
				5	13.3
				4.5	10
				4	6.7
Ideomotor		Digits Forward		Digits Backward	
3	6.7	5	66.7	5	96.7
1	3.3	4	43.3	4	80
		3	23.3	3	53.3
		2	6.7	2	30
				1	13.3



HIGH SCHOOL ALZHEIMER'S GROUP

TOTAL SCORE

SCORE	PERCENTILE	SCORE	PERCENTILE	SCORE	PERCENTILE
108.5	99	98	67.4	83	34.7
108	98	97	63.3	82	32.7
106.5	96.9	95.5	61.2	80.5	30.6
106	93.8	94.5	59.2	80	26.5
105.5	91.8	93	55.1	79.5	22.5
105	89.8	92	53.1	78.5	20.4
103	87.8	91.5	50	78	18.4
102.5	85.7	91	46.9	76.5	14.3
101.5	79.6	90	44.9	75.5	10.2
101	77.6	89	42.9	75	8.2
100.5	75.5	88	40.8	68	6.1
100	73.5	85	38.8	66.5	4.1
99	69.4	83.5	36.7	59.5	2

MEMORY

SCORE	PERCENTILE	SCORE	PERCENTILE	SCORE	PERCENTILE
41.5	98	32	61.2	24.5	24.5
40	95.9	31	57.1	24	22.5
39	93.9	30	55.1	23.5	20.4
38	91.8	29.5	53.1	23	18.4
37.5	89.8	29	51	22.5	16.3
36	85.7	28	49	21.5	14.3
35	81.8	27.5	44.9	21	12.2
34.5	77.6	27	42.9	20.5	8.2
33.5	75.5	26	40.8	19.5	6.1
33	71.4	25.5	36.7	19	4.1
32.5	69.4	25	28.6	18.5	2

**LANGUAGE**

SCORE	PERCENTILE	SCORE	PERCENTILE
39	67.4	33	18.4
38	61.2	32	10.2
37	42.9	31	6.1
36	36.7	30	4.1
35	28.6	29	2.0
34	22.5		

VISUAL-MOTOR

SCORE	PERCENTILE	SCORE	PERCENTILE
31	83.7	21	26.5
30	73.4	20	22.5
29	57.1	19	18.4
27	53.1	18	12.2
26	49	17	10.2
25	44.9	16	8.2
24	40.8	14	6.1
23	36.7	12	2
22	32.7		



SUB-TEST SCORE PERCENTILES FOR HIGH SCHOOL GROUP *

SCORE	%ile	SCORE	%ile	SCORE	%ile
Orientation		Word Finding		Verbal Comp.	
10	63	10	24.5	10	2
9	43	9	16.3		
8	29	8	8.2		
7	27	7	2		
6	23				
5	10				
4	6.1				
3	2				
Spatial Reversal		Calculation		Copying	
5	41	4	34.7	4	14.3
		3	4.1	2	10.2
				1	8.2
Perseveration		Abstract Thinking		Clock Drawing	
2	43	8	57.1	7	81.6
1	4.1	7	49	6	69.4
		6	38.8	5	53
Reading		5	18.4	4	51
3	10.2	4	16.3	3	32.7
2	2	3	6.1	2	22.5
		2	4.1	1	12.2

* See note 7 on page 45.



SCORE	%ile	SCORE	%ile	SCORE	%ile
Visual Memory		R L Orientation		Writing	
5	71.4	10	10.2	4	4.1
4	63.3	8	6.1	3	2
3	38.8				
2	22.5				
1	10.2				
Word Recall		Delayed Recall		Word Recognition	
6	95.9	4	98	10	98
5	89.8	3	95.9	9.5	92
4	71.4	2	77.6	9	84
3	44.9	1	55.1	8.5	80
2	22.5			8	74
1	8.2			7.5	71
				7	53.1
				6.5	43
				6	32.7
				5	14.3
				5	10.2
				4.5	4.1
				4	2
Ideomotor		Digits Forward		Digits Backward	
3	2	5	91.8	5	91
		4	22.5	4	63.3
		3	6.1	3	28.6
				2	8.2
				1	2

**POST SECONDARY SCHOOL ALZHEIMER'S GROUP****TOTAL SCORE**

SCORE	<i>PERCENTILE</i>	SCORE	<i>PERCENTILE</i>	SCORE	<i>PERCENTILE</i>
107.5	97.4	98	64.1	90	23.1
107	94.9	97	59	88	20.5
106.5	92.3	95.5	58.4	87.5	18
105.5	87.2	95	51.3	86.5	15.4
105	84.6	94.5	48.7	83	12.8
104	82.1	94	43.6	82.5	10.3
103.5	78.9	93.5	38.5	76	7.7
100	74.4	93	35.9	75.5	5.1
99	69.2	92	33.3	72.5	2.6
98.5	66.7	91	28.2		

MEMORY

SCORE	<i>PERCENTILE</i>	SCORE	<i>PERCENTILE</i>	SCORE	<i>PERCENTILE</i>
40	97.4	33	64.1	27	25.6
37.5	94.9	32	59	26	23.1
37	92.3	31	48.7	25.5	15.4
36.5	84.6	30.5	46.2	25	12.2
36	82.1	30	43.6	23	7.7
35.5	79.5	29	41	21.5	2.6
35	74.4	28	38.5		
33.5	66.7	27.5	35.9		

LANGUAGE

SCORE	<i>PERCENTILE</i>	SCORE	<i>PERCENTILE</i>
39	64.1	34	10.3
38	43.6	33	5.1
37	30.8	32	2.6
36	15.4		



VISUAL-MOTOR

SCORE	<i>PERCENTILE</i>	SCORE	<i>PERCENTILE</i>
31	71.8	24	28.2
30	64.1	23	23.1
29	53.9	22	20.5
28	46.2	21	12.8
27	38.5	20	5.1
25	35.9	15	2.6

:



SUB-TEST SCORE PERCENTILES FOR POST SECONDARY SCHOOL GROUP *

SCORE	%ile	SCORE	%ile	SCORE	%ile
Orientation		Word Finding		Verbal Comprehension	
10	46.2	10	20.5	10	7.7
9	28.2	9	5.1		
8	20.5	8	2.6		
7	15.4				
6	7.7				
4	5.1				
Spatial Reversal		Calculation		Copying	
5	31	4	28.2	4	12.8
		3	5.1	3	2.6
Perseveration		Abstract Thinking		Clock Drawing	
2	33	8	38.5	7	66.7
1	13	7	33.3	6	56.4
		6	15.4	5	46.2
		5	10.3	4	30.8
Reading Comprehension		3	2.6	3	15.4
3	12.8			2	7.7

* See note 7 on page 45.



SCORE	%ile	SCORE	%ile	SCORE	%ile
Visual Memory		R L Orientation		Writing	
6	92.3	10	12.8	4	5.1
5	61.5	9	2.6		
4	30.8				
3	12.8				
2	2.6				
Word Recall		Delayed Recall		Word Recognition	
6	94.9	4	97.4	8.5	87.2
4	74.4	3	87.2	8	76.9
3	56.4	2	74.4	7.5	64.1
2	33.3	1	66.7	7	48.7
1	10.3			6.5	46.2
				6	30.8
				5.5	17.9
				5	7.7
				4.5	5.1
				4	2.6
Ideomotor		Digits Forward		Digits Backward	
3	5.1	5	46.2	6	94.9
		4	15.4	5	89.7
		3	2.6	4	59
				3	28.2
				2	2.6

OTHER DEMENTIAS GROUP

	MEAN	STD DEV	STD ERR	MIN	MAX
AGE OF SUBJECT	75.13	7.71	1.19	57	94
YEARS OF EDUCATION	11.67	3.32	0.56	4	20
DURATION OF ILLNESS	2.50	1.98	0.31	0	10
ORIENTATION	9.17	1.16	0.18	5	10
WORD RECALL	3.44	1.70	0.26	0	8
DELAYED RECALL	1.39	1.58	0.24	0	6
WORD RECOGNITION	6.77	1.85	0.29	2	10
VISUAL MEMORY	3.70	1.49	0.23	1	6
DIGITS FORWARD	4.59	0.77	0.12	1	5
DIGITS BACKWARD	2.81	1.07	0.16	1	4
WORD FINDING	9.72	0.92	0.14	4	10
READING COMPREHENSION	2.93	0.33	0.05	1	3
WRITING	3.96	0.27	0.04	2	4
VERBAL COMPREHENSION	9.96	0.27	0.04	8	10
ABSTRACT REASONING	6.59	1.65	0.26	2	8
CALCULATION	3.50	0.75	0.12	1	4
RIGHT-LEFT ORIENTATION	9.70	0.79	0.12	7	10
COPYING TASK	3.80	0.59	0.09	1	4
SPATIAL REVERSAL	3.61	2.26	0.35	0	5
IDEOMOTOR	2.93	0.26	0.04	2	3
CLOCK TEST	4.44	2.35	0.36	0	7
PERSEVERATION	1.70	0.57	0.09	0	2
TOTAL SCORE	94.73	10.04	1.55	61	116
SUB TOTALS					
LANGUAGE	36.67	2.27	0.35	30	39
VISUAL-MOTOR	26.19	4.67	0.72	13	31
MEMORY	31.88	5.75	0.89	18	46

n = 54



OTHER DEMENTIAS GROUP - PERCENTILES

TOTAL SCORE

SCORE	PERCENTILE	SCORE	PERCENTILE	SCORE	PERCENTILE
112.5	98.1	100	69.8	92.5	35.9
111.5	96.2	99.5	67.9	91.5	34
110.5	94.3	99	66	90.5	32.1
108	92.5	98	62.3	90	28.3
107.5	90.6	97	60.4	89.5	26.4
107	88.7	96	58.5	89	24.5
105.5	86.8	95.5	54.7	88.5	20.8
104	84.9	95	50.9	86	17
103.5	81.1	94.5	49.1	84	13.2
102.5	79.3	94	45.3	83	5.7
101.5	77.4	93.5	43.4	78.5	3.8
100.5	73.6	93	39.6	76.5	1.9

MEMORY

SCORE	PERCENTILE	SCORE	PERCENTILE	SCORE	PERCENTILE
44.5	98.1	33.5	67.9	28.5	24.5
42.5	94.3	33	66.1	28	20.8
40	92.5	32	52.8	27.5	18.9
38.5	88.7	31.5	49.1	27	13.2
38	86.8	31	45.3	26.5	9.4
37.5	84.9	30.5	41.5	25.5	7.6
37	81.1	30	37.7	24	5.7
36.5	77.4	29.5	34	22	3.8
35	69.8	29	30.2	19.5	1.9

LANGUAGE

SCORE	PERCENTILE	SCORE	PERCENTILE	SCORE	PERCENTILE
39	75.5	36	22.6	33	5.67
38	58.5	35	20.8	32	3.8
37	37.7	34	11.3	31	1.9



VISUAL-MOTOR

SCORE	PERCENTILE	SCORE	PERCENTILE	SCORE	PERCENTILE
31	79.3	26	34	19	5.7
30	73.6	25	28.3	17	3.8
29	58.5	23	20.8	16	1.9
28	52.8	22	18.9		
27	41.5	20	15.1		



SUB-TEST SCORE PERCENTILES FOR OTHER DEMENTIAS GROUP *

SCORE	%ile	SCORE	%ile	SCORE	%ile
Orientation		Word Finding		Verbal Comprehension	
10	43	10	15	10	1.9
9	28	9	5.7		
8	9.4	8	1.9		
7	1.9				
Spatial Reversal		Calculation		Copying	
5	28	4	38	4	13
		3	11	3	5.7
		2	1.9	2	1.9
Perseveration		Abstract Thinking		Clock Drawing	
2	24.5	8	55	7	71.7
1	5.7	7	45	6	58.5
		6	21	5	45.3
Reading Comprehension		5	13	4	39.6
3	5.7	4	7.6	3	22.6
2	1.9	3	1.9	2	15.1
				1	7.6

* See note 7 on page 45.



SCORE	%ile	SCORE	%ile	SCORE	%ile
Visual Memory		R L Orientation		Writing	
6	86.8	10	15.1	4	1.9
5	71.7	9	9.4		
4	43.4	8	5.7		
3	24.5				
2	7.6				
Word Recall		Delayed Recall		Word Recognition	
8	100	6	100	10	98
7	98.1	5	96.2	9	87
6	88.7	4	92.5	8	72
5	77.4	3	79.3	7	49
4	56.6	2	54.7	6	25
3	30.2	1	47.2	5	13
2	7.6			4	5.7
1	5.7				
Ideomotor		Digits Forward		Digits Backward	
3	7.6	5	30.2	4	68
		4	7.6	3	38
		3	1.9	2	15



DEPRESSION GROUP

	MEAN	STD DEV	STD ERR	MIN	MAX
AGE OF SUBJECT	76.25	6.94	1.07	66	89
YEARS OF EDUCATION	11.16	2.83	0.44	6	17
DURATION OF ILLNESS	14.85	14.32	2.21	1	53
ORIENTATION	9.91	0.39	0.06	8	10
WORD RECALL	3.50	1.39	0.21	0	6
DELAYED RECALL	2.44	1.44	0.22	0	5
WORD RECOGNITION	7.77	1.24	0.19	5	10
VISUAL MEMORY	4.09	1.75	0.27	0	6
DIGITS FORWARD	4.88	0.42	0.06	3	5
DIGITS BACKWARD	3.38	0.83	0.13	1	4
WORD FINDING	9.97	0.18	0.03	9	10
READING COMPREHENSION	2.94	0.25	0.04	2	3
WRITING	3.94	0.25	0.04	3	4
VERBAL COMPREHENSION	10.00	0.00	0.00	10	10
ABSTRACT REASONING	6.75	1.74	0.27	1	8
CALCULATION	3.81	0.40	0.06	3	4
RIGHT-LEFT ORIENTATION	9.88	0.42	0.06	8	10
COPYING TASK	4.00	0.00	0.00	4	4
SPATIAL REVERSAL	4.06	1.96	0.31	0	5
IDEOMOTOR	3.00	0.00	0.00	3	3
CLOCK TEST	5.63	1.64	0.25	2	7
PERSEVERATION	1.88	0.34	0.05	1	2
TOTAL SCORE	101.80	7.61	1.17	87	113
SUB TOTALS					
LANGUAGE	37.41	1.95	0.30	31	39
VISUAL-MOTOR	28.44	3.19	0.49	21	31
MEMORY	35.95	4.67	0.72	28	43

n = 32



DEPRESSION GROUP - PERCENTILES

TOTAL SCORE

SCORE	PERCENTILE	SCORE	PERCENTILE	SCORE	PERCENTILE
112.5	96.8	106	61.3	94	19.4
112	93.6	105.5	54.8	93.5	16.1
110.5	90.3	103	48.4	93	12.9
109.5	87.1	102	45.2	92	9.7
109	80.7	101	41.9	90	6.5
108.5	74.2	100.5	38.7	89.5	3.2
107.5	71	97	29		
107	67.7	95	25.8		

MEMORY

SCORE	PERCENTILE	SCORE	PERCENTILE	SCORE	PERCENTILE
42.5	90.3	38.5	64.5	35	35.5
42	87.1	38	61.3	33	25.8
40.5	83.9	37	58.1	32.5	22.6
40	77.4	36.5	54.8	32	19.4
39.5	71	36	45.2	31	16.1
39	67.7	35.5	41.9	29	6.5

LANGUAGE

SCORE	PERCENTILE	SCORE	PERCENTILE	SCORE	PERCENTILE
39	58.1	37	35.5	34	3.2
38	41.9	36	9.7		

VISUAL-MOTOR

SCORE	PERCENTILE	SCORE	PERCENTILE	SCORE	PERCENTILE
31	67.7	28	29	23	9.7
30	48.4	27	22.6	22	6.5
29	32.3	26	16.1		



SUB-TEST SCORE PERCENTILES FOR DEPRESSION GROUP *

SCORE	%ile		SCORE	%ile		SCORE	%ile
Orientation			Word Finding			Verbal Comprehension	
10	6.5		10	3.9		10	1 >
9	3.2						
Spatial Reversal			Calculation			Copying	
5	19.4		4	23.1		10	1 >
Perseveration			Abstract Thinking			Clock Drawing	
2	13		7	54.8			
			7	38.7		6	41.9
			6	19.4		5	22.6
Reading Comprehension			5	9.7		4	16.1
3	7.7		4	6.5		3	6.5
			3	3.2			

* See note 7 on page 45.



SCORE	%ile	SCORE	%ile	SCORE	%ile
Visual Memory		R L Orientation		Writing	
6	76.9	10	7.7	4	7.7
5	50	9	3.9		
4	42.3				
3	23.1				
2	11.5				
1	3.9				
Word Recall		Delayed Recall		Word Recognition	
6	93.6	5	96.8	9.5	83.9
5	83.9	4	80.7	9	77.4
4	48.4	3	48.4	8.5	67.7
3	22.6	2	22.6	8	54.8
2	6.5	1	16.1	7.5	45.2
1	3.2			7	16.1
				6.5	9.7
				6	3.2
Ideomotor		Digits Forward		Digits Backward	
3	1 >	5	11.5	4	50
		4	3.9	3	19.2
				2	3.9

Normative Groups Frequency Distributions

