

Mini- Kingston Standardized Cognitive Assessment (REV) (mini-KSCAr)

Instruction and Scoring Manual

Semoprs Mental Health, Providence Care Mental Health Services
Kingston, Canada K7L 4X3

The Kingston Scales and Manuals can be downloaded free of charge from:

www.kingstonscales.ca

email: kscales@queensu.ca

© Copyright 2015 R.W. Hopkins, L.A. Kilik



TABLE OF CONTENTS	
Introduction	4
SUB-TEST SCORING	
1 Word Recall	5
2 Orientation	6
3 Abstract Thinking	7
4 Clock Drawing	8
5 Delayed Word Recall	15
6 Word Recognition	16
Mini-KSCAr Score Analysis	17
Frequently Asked Questions	18
NORMATIVE DATA	
Total Score Percentiles (Normals and Dementia - to nearest 5 th percentile)	19
Normal Group Statistics and Percentiles	20
Alzheimer's Group Statistics and Percentiles	21
Alzheimer's Education Norms Percentiles	23
Other Dementias Group Statistics and Percentiles	28
Depression Group Statistics and Percentiles	30
Normative Groups Frequency Distribution Charts	32



Introduction

The mini-Kingston Standardized Cognitive Assessment - Revised (mini-KSCAr) is an instrument that has been derived from the full KSCAr (Hopkins et al., 2004) and designed to very quickly screen individuals suspected of having brain damage; especially early stage dementias as commonly seen in the elderly. Individuals can be compared to a group of outpatients with probable Alzheimer's disease (Dementia Group) or to a community dwelling normal elderly sample. Norms are also provided for a group of outpatients who were diagnosed with depression, but not dementia. While it is not in itself diagnostic, the mini KSCAr alerts the user to the possibility of an existing organic process and raises the question of whether further evaluation is needed.

One of the main values of the mini-KSCAr is that it allows one to screen for potential brain damage in patients without special training in mental measurement, or specially trained personnel, and can typically be completed in about 10 minutes (no longer than most other brief dementia screens). The companion to this manual is the "Assessment Form" which is the protocol used to assess a patient and contains all of the forms necessary; only a pencil needs to be provided.

In addition to the mini-KSCAr, there is the full KSCAr which is a longer and more wide ranging version, and the *BriefKSCAr* which is shorter than the full version but not as brief as the mini-KSCAr. While the full KSCAr is recommended for initial or more comprehensive screening, especially when the scope of the possible brain damage is unclear, the mini-KSCAr (or *BriefKSCAr*) can be used as a fast and reliable "in office" or bedside procedure that yields more, and more reliable, data than other short cognitive screening tools commonly in use. It can also be used to monitor a patient's change over time.

General Scoring Notes:

- Many elderly people have some degree of hearing loss; make sure the patient understands the questions and instructions. Speak slowly and clearly; ask him/her to let you know if he/she has trouble understanding you. Repeat if necessary. In addition, many patients have some degree of visual impairment; make sure the patient can see adequately.
- If the patient gives a wrong response but corrects him/herself spontaneously, BEFORE starting the next sub-test, the second response IS scored; but DON'T use the self-corrected answers that occur after you have gone on to something else, use the original response for scoring purposes.
- If you wish to probe a patient further (i.e., "testing the limits") you may do so; make note of any additional responses, but SCORE ONLY THE ORIGINAL RESPONSE. WRITE DOWN ALL RESPONSES. The response lines are provided not just to make occasional notes but to make the mini-KSCAr a complete record of the assessment that can be compared to future examinations.
- IF A SUB-TEST IS NOT SCORED FOR ANY REASON, A TOTAL SCORE **CANNOT** BE OBTAINED. FAILURE OF A PATIENT TO COMPLETE A SUB-TEST RESULTS IN A SCORE OF ZERO FOR THAT SUB-TEST



Introduction

The Use of This Manual

While the Assessment Form contains administration instructions and some statistical data, this manual does so in greater detail, and in addition, provides information about the scoring and interpretation of the mini-KSCAr.

Each sub-test section is organized under the same headings: **Name, Purpose, Administration Instructions** (with what the examiner actually says to the patient shown in **UPPER CASE AND BOLDED**), **Scoring Procedure, Maximum Total Score, Acceptable Answers** (and sometimes unacceptable answers), **Interpretation, Templates** (where applicable), and **Examples** (where applicable).

One feature found in the mini-KSCAr that is rarely found in other scales, is the provision of templates to aid in scoring the Clock Test. The templates are produced in the proper size to allow the examiner to place the patient's reproduction over top of the template to determine whether the angles or spacing etc., are correct. Sometimes if the templates (A & B) are printed on clear overheads, they can be more easily used.

While each sub-test has an interpretation section, this is only intended as a guide. Those listed are common interpretations, used most frequently when a patient is suffering from a progressive dementia such as Alzheimer's Disease. However, where different etiologies are involved, alternative interpretations may be applicable.

This manual contains statistics (i.e. means, percentiles, etc.) for groups of normal elderly (p. 21), Alzheimer's patients (p. 22), and a group of depressed patients (p. 31). A group of other or mixed dementias are represented by the "Other Dementia" group on page 29, and norms for the Alzheimer's group according to education level are found starting on page 24. The group labelled "Dementia", on the Assessment Form is the Alzheimer's group. When newly assessing a patient for whom there is no definitive diagnosis, this group should be used for a first comparison. If the individual is known, or suspected of having a diagnosis of depression, then that group should be used for comparison purposes. It should be noted that the Alzheimer's group used in these norms is drawn from a community living sample.

Increasingly, it is becoming apparent that a more complete and effective assessment of a suspected dementia should also include a behavioural assessment, such as can be obtained by using the Kingston Standardized Behavioural Assessment (KSBA) (Hopkins, et. al., 2006).

See:

Hopkins R, Kilik L, Day D, Rows C, Hamilton P. (2004). The Revised Kingston Standardized Cognitive Assessment. *Int J Geriatr Psychiatry* **19**, 320-326.

Hopkins R, Kilik L, Day D, Rows C, Hamilton P. 2005. The Brief Kingston Standardized Cognitive Assessment -Revised. *Int J Geriatr Psychiatry* **20**, 227-231.

Hopkins R, Kilik L, Day D, Bradford L, Rows C, (2006) "Kingston Standardized Behavioural Assessment" *The American Journal of Alzheimer's Disease and Other Dementias*, **21**: 339-346.



SUBTEST NO. 1		WORD RECALL
Purpose	To assess short term verbal memory	
Administration Instructions	Use the 10 word list (TABLE, FOOTBALL, WINDOW ... APPLE). Using a blank sheet of paper (supplied), slide it down the list of words, sequentially exposing the list one word at a time. Present each word for 2 seconds. Ask the subject to “PLEASE READ ALOUD EACH WORD THAT I SHOW YOU.” DO NOT TELL THE SUBJECT TO TRY AND REMEMBER THEM. After presenting all 10 words, cover the list completely or otherwise ensure that it is not visible and ask the subject “PLEASE TELL ME AS MANY OF THE WORDS FROM THAT LIST AS YOU CAN, IN ANY ORDER.”	
Scoring Procedure	1 Point for each correct response.	
Maximum Total Score	10	
Interpretation	Poor performance on short term recall tasks such as this is a common feature in most forms of brain damage.	
Acceptable Answers	The recalled words must be exact, no synonyms.	



SUBTEST NO. 2		ORIENTATION
Purpose	To assess recent memory through general level of orientation to person, time and place.	
Administration Instructions	Ask each as presented in quotation marks below. [REMEMBER TO WRITE DOWN ALL RESPONSES]	
Scoring Procedure	One point per question is given for each correct response.	
Maximum Total Score	10	
Interpretation	A poor performance suggests problems with short term or recent memory. This is a common finding in typical dementias such as Alzheimer's disease but is not necessarily a prominent feature in other forms of dementia. Especially those that are not progressive such as delirium.	
Acceptable Answers		
1. "WHAT IS YOUR FULL NAME?"	- at least one given name & last name	
2. "WHAT IS YOUR AGE?"	- age, not 'date of birth', if they give DOB say "Yes, but how old does that make you."	
3. "WHAT IS YOUR BIRTH DATE?"	- date of birth, not 'birthday'	
4. "WHERE ARE WE NOW?"	- at least 'hospital', or type, or name of institution - whatever type of building it is (e.g., house, apartment, nursing home)	
5. "WHAT CITY (TOWN etc.) IS THIS?"	- name of city, town, village (not subdivision)	
6. "WHAT DAY OF THE WEEK IS THIS?"	- correct day	
7. "WHAT MONTH IS THIS?"	- correct month	
8. "WHAT YEAR IS THIS?"	- correct year	
9. "WHAT IS THE TIME OF DAY?"	- correct time within 90 min.	
10. "WHAT IS THE SEASON?"	- correct season	



SUBTEST NO. 3		ABSTRACT THINKING
Purpose	To assess one's ability to perform abstract reasoning.	
Administration Instructions	Ask each question as written. Prompt responses only on the first two.	
Scoring Procedure	General Remarks: 2 Points - highest level of appropriate abstraction or major use 1 Point - minor similarities; superficial or descriptive only	
Maximum Total Score	8	
Interpretation	Difficulties with this task suggest problems in abstract reasoning, which is an executive function often associated with frontal lobe damage.	
Acceptable Answers		
1. "In what way are carrots and beans alike?"	2 Points - vegetables; you eat them; food; 1 Point - have vitamins; grow in ground; plants; If patient fails to give a 2-point answer say, "THEY ARE BOTH VEGETABLES."	
2. "In what way are a shirt and a sweater alike?"	2 Points - clothing; apparel; attire; you wear them; 1 Point - they are made of cloth (material); have sleeves (buttons); cover upper part of the body; [same help as above]	
3. "In what way are a dog and a cow alike?"	2 Points - animals (mammals); 1 Point - they have 4 legs; are found on farms. [no help]	
4. "In what way are a car and a bicycle alike?"	2 Points - means of transportation (travelling); vehicles; - they take you places; you ride them; 1 Point - they have wheels; carry people; you steer them. [no help]	



SUBTEST NO. 4		CLOCK DRAWING
Purpose	Clock drawing is another test of visual-motor functioning.	
Maximum Total Score	7	
Interpretation	Clock drawing is a sensitive measure of visual-motor function, and problems with this task are often seen as an early sign of dementia.	
Administration Instructions a) NUMBERS [1 st blank - circle]	"I WANT YOU TO WRITE IN THE NUMBERS, AS ON A CLOCK FACE" If patient writes only some of the numbers, e.g. 3,6,9,12, say, "PLEASE, WRITE ALL OF THE NUMBERS" Make sure that the top of the clock (i.e. the 12), is at the top of the page. If not, mark top (i.e. patient's top).	
Scoring Procedure a) NUMBERS	USE FIGURE A and examples on page ??. 2 Points - numbers 1 - 12 (and no extra numbers) fairly straight and nearly evenly spaced around periphery, with the 12 at the top. When the reproduction is placed over Figure I with the 12 placed at the top of vertical line (L L'), the major part of the 3, 6 and 9 should be in the appropriate areas marked 'a'; - main bodies of <u>ALL</u> numbers should be within the outer ring marked 'b'; - not more than one number rotated 90 degrees or more 1 Point - some distortion in spacing of numbers is acceptable, i.e., when reproduction is placed over Figure A, so that the 12 lies on the vertical line (L L'), the major part of any <u>2</u> of the numbers 3, 6 and 9 should be in the appropriate areas marked 'a'; - main bodies of all but <u>1</u> of the numbers should be within the outer ring 'b'; - no extra numbers can be included	
Maximum Score a) NUMBERS	2	
Administration Instructions b) 9:00 [2 nd blank - circle]	"ON THIS CIRCLE DRAW IN THE HANDS TO MAKE IT SAY 9 O'CLOCK."	



SUBTEST NO. 4	CLOCK DRAWING
Scoring Procedure b) 9:00	USE FIGURE B and examples on page ??. 2 Points - using Figure B, the vertex should be centred within the area marked 'a', the 'hands' should fall in the tracks marked 'b'. - 'hands' should be connected (or almost connected) at an approximate right angle; - hour 'hand' SHORTER than minute 'hand'. 1 Point - connecting point of 'hands' off-centre but within the larger central circle marked 'c'; - hour 'hand' NOT LONGER than minute hand; - if 'hands' are not connected, both should radiate from larger central area marked 'c'
Maximum Score b) 9:00	2
Administration Instructions c) 10:05 [3 rd circle - numbered]	"NOW TRY THIS ONE. PUT IN THE HANDS FOR 5 PAST 10. MAKE IT SAY 5 PAST 10"
Scoring Procedure c) 10:05	- follow scoring guidelines for 9:00 o'clock. See examples on page ??. - place 10:05 clock face over Figure B, and rotate it so that the numbers 10 and 1 are inside the shaded areas marked 'a';
Maximum Score c) 10:05	2
Administration Instructions d) 8:20 [4 th circle - numbered and hands]	Say , "WHAT TIME IS IT ON THIS CLOCK?"
Scoring Procedure d) 8:20	1 point for 8:20 (or 20 past 8)
Maximum Score d) 8:20	1

Templates: - Figure A

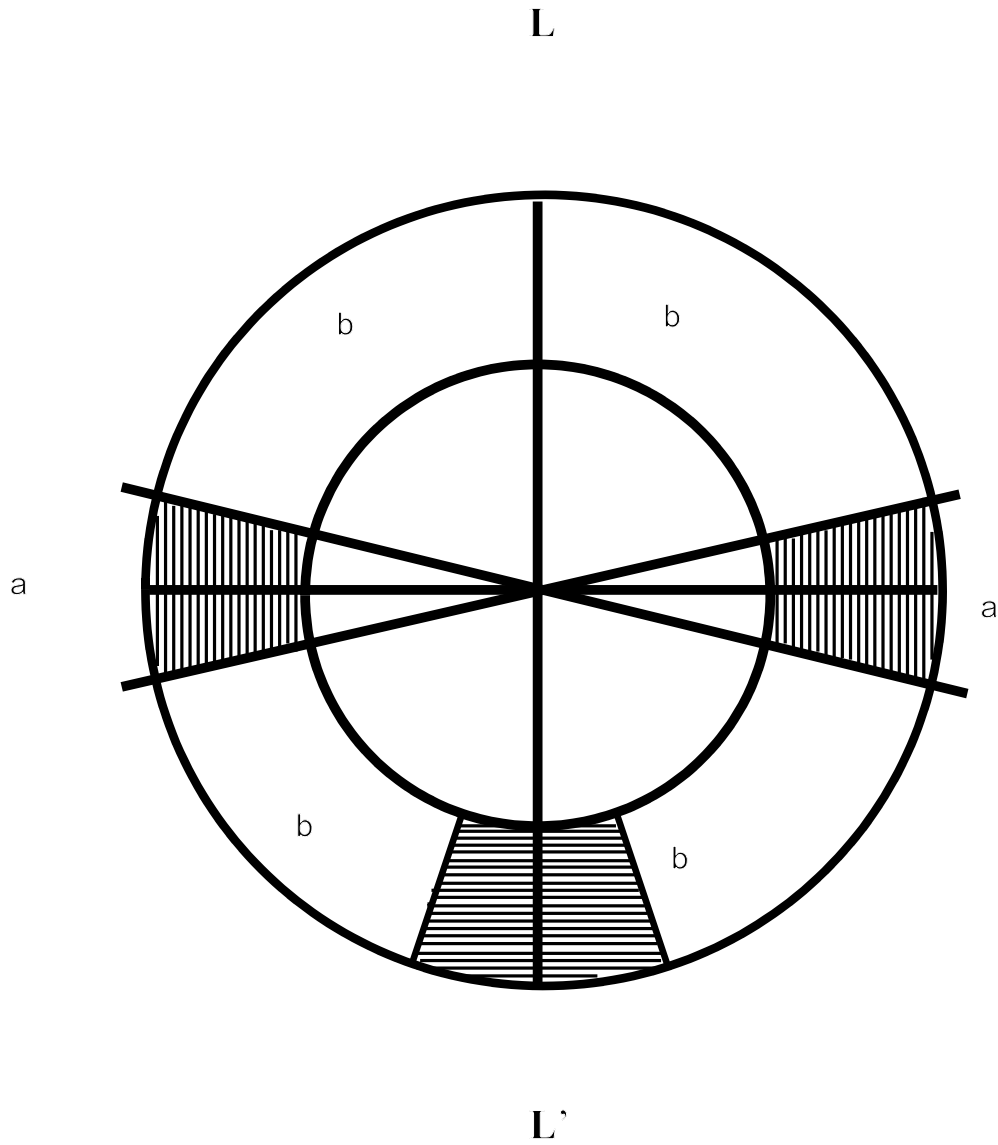
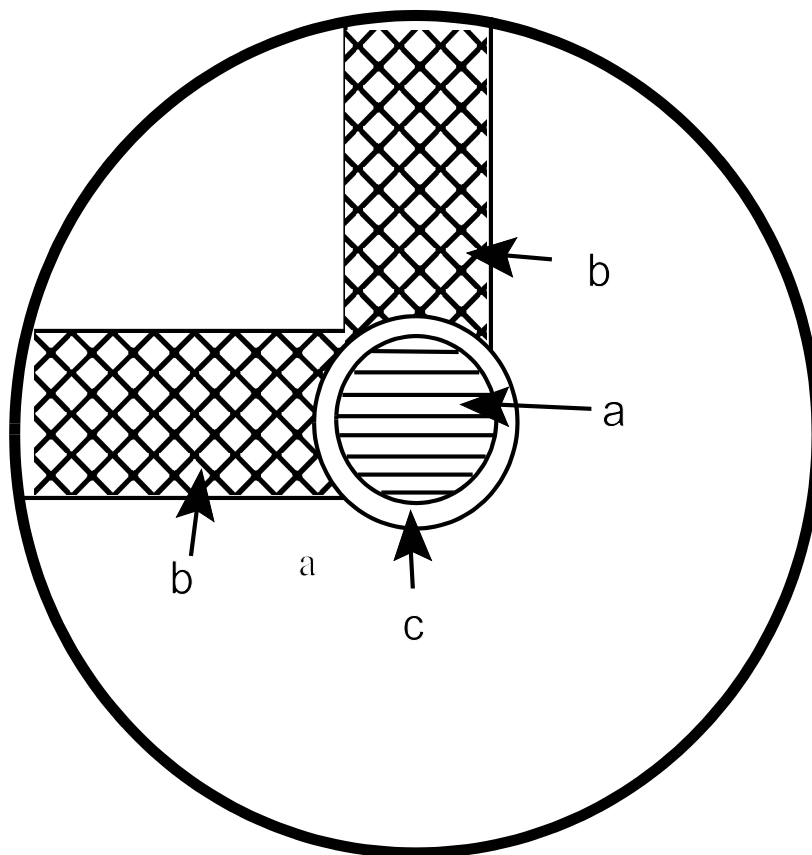

Figure B





Examples: -

Numbers:

2 Points

1 Point

0 Points

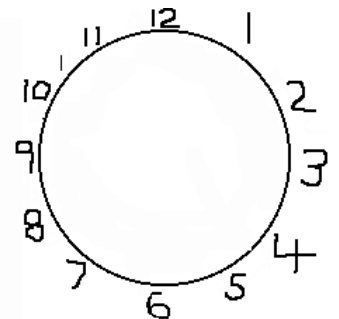
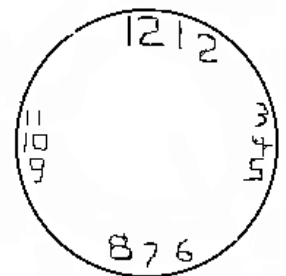
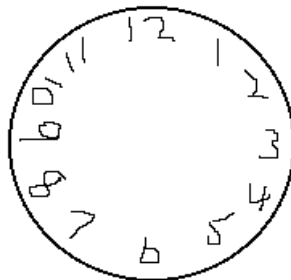
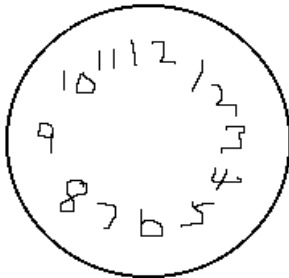
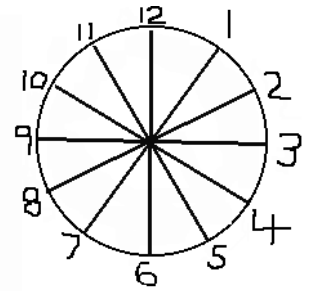
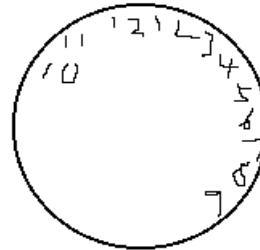
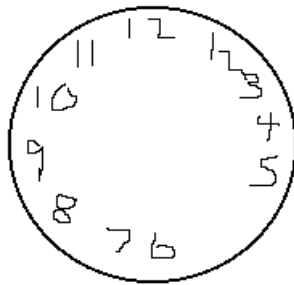
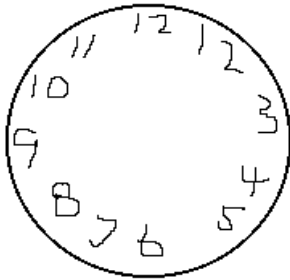



9:00:

2 Points

1 Point

0 Points

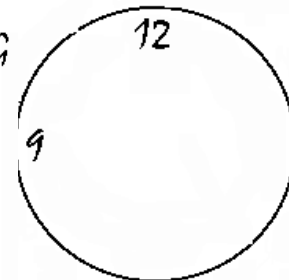
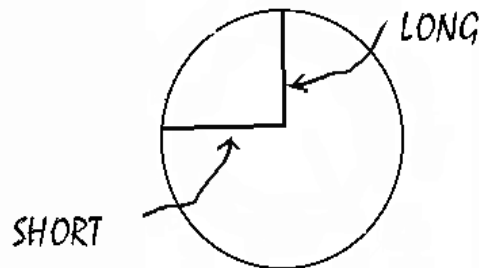
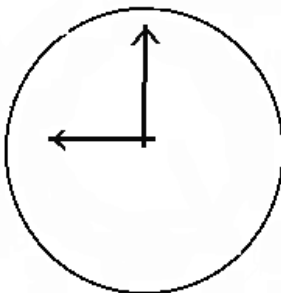
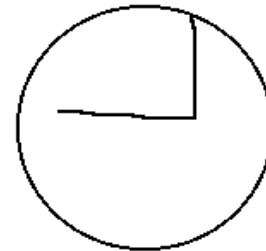
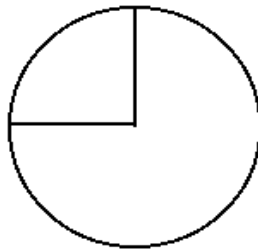
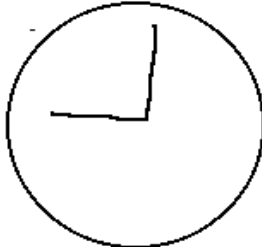
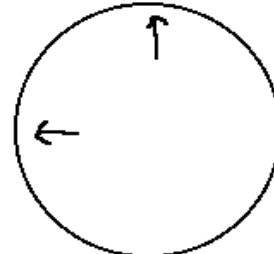
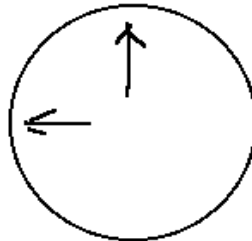
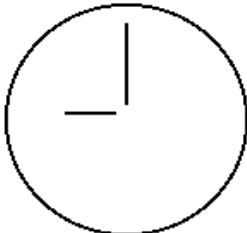
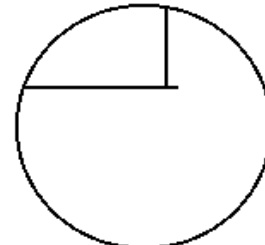
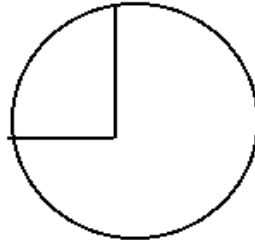
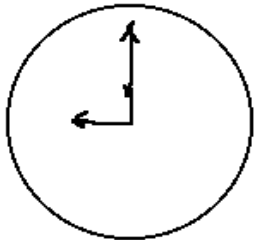



10:05:

2 Points

1 Point

0 Points

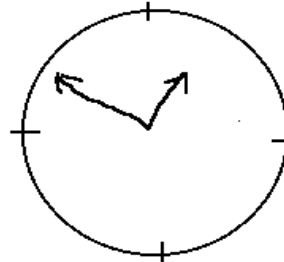
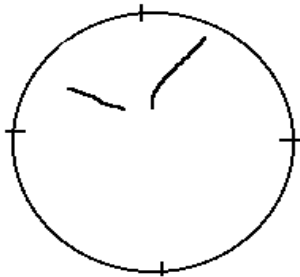
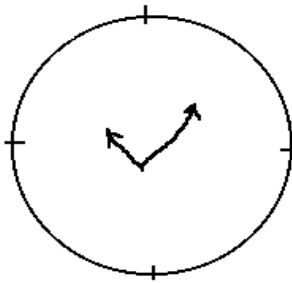
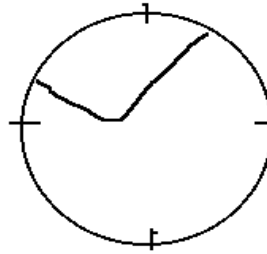
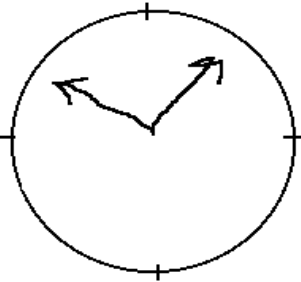
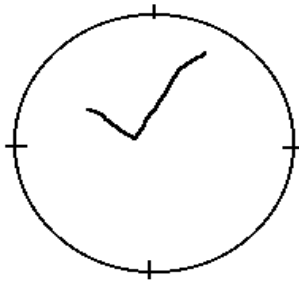



SUBTEST NO. 5		DELAYED WORD RECALL
Purpose	To assess short term verbal memory with a delay.	
Administration Instructions	After 15 minutes (approximately) ask the subject “PLEASE TELL ME AS MANY WORDS THAT YOU CAN REMEMBER FROM THE LIST THAT I SHOWED TO YOU EARLIER, IN ANY ORDER.”	
Scoring Procedure	1 Point for each correct response	
Maximum Total Score	10	
Interpretation	A delay between learning and recall is not usually problematic for someone without brain damage, but if brain damage is present it often shows up as a reduced capacity to remember material after a delay. This is often one of the first signs of brain damage.	
Acceptable Answers	Responses must match the words on the list exactly. Substitutions or intrusions are not scored but should be noted.	



SUBTEST NO. 6	WORD RECOGNITION
Purpose	To assess one's ability to make use of partial information in assisting one to recognize learned material.
Administration Instructions	After completing the delayed recall, show the subject the second list of 20 words [2 sheets] (TABLE, HOUSE, BOWL, .. BIRD), point to the first word and say to the subject “DID YOU SEE THIS WORD ON THE LIST THAT I SHOWED TO YOU EARLIER OR IS THIS A NEW WORD?” Repeat these instructions for the 2nd word. But for the 3rd word say “HOW ABOUT THIS ONE?” For the 4th word onward, use either instruction as seems necessary. After completing the 1st page, go to the second one (GLOVE, KING)
Scoring Procedure	1 Point for each word correctly identified as being either “in” or “not in” the list. Divide points by 2 for total score out of 10. i.e. $IN/10 + NOT\ IN/10 = Total/20 \div 2$ (max = 10)
Maximum Total Score	10
Interpretation	Usually patients suffering from Alzheimer's disease will perform relatively poorly on free recall and delayed recall, but will perform at near normal levels on recognition memory.



mini-KSCAr SCORE ANALYSIS

This section is designed to make the analysis of mini-KSCAr scores easier and more meaningful. To aid in this, the mini-KSCAr scores are translated into **percentiles** which make the scores more easily compared across patients. Percentiles are a simple way of describing how well a person performed relative to a larger group of people on a particular task. If there were a number of different people being compared on a test, normally their performances would vary; some would do poorly and others would do very well. These scores could then be ranked from lowest to highest. Percentiles do this using a scale of 1 to 100. Someone with an excellent score would have more people who did worse than that person did, and fewer who did better, so their ranking would be higher (e.g., the 90th percentile). Conversely, someone who did poorly on that test would be ranked lower, as more people were able to do better (e.g., the 20th percentile). If someone has a score at the 70th percentile, it can be said that he or she performed as well or better than 70 percent of the people that have taken the test. If you were a person with a score that was right in the middle, you'd be ranked at the 50th percentile, meaning there were as many people who did better than you on that test as there were people who did worse than you. In general, percentiles make interpreting performance easier, as scores are always converted to a scale of 1 to 100.

After a patient has completed a mini-KSCAr and you have scored all the sub-tests, tally the scores on the "Scoring Summary" (page 1), then, use the tables below it to calculate the percentiles compared to the "Dementia" and "Normal" groups. Most often the scores will only fall in one of the ranges.

STEP 1: MAKE AN ESTIMATION OF THE LEVEL THAT THE PATIENT FUNCTIONED AT PRIOR TO HIS OR HER CURRENT ILLNESS (or condition that resulted in this assessment).

This is called the **premorbid** level of functioning.

Did the individual have more than average education (or less)? Did the individual have a number of hobbies? More education, and more hobbies or interests usually indicate higher levels of functioning. How do family and friends regard the individual? Do they describe the individual as "smart", "very bright" or "clever", or the opposite, or "average". Remember that most people will fall into the "average" range unless, you have some clear evidence, such as suggested above, that they functioned above or below it.

STEP 2: USING THE CHART LABELLED "NORMALS" AND CIRCLE THE PATIENT'S TOTAL SCORE (left hand column). READ THE CORRESPONDING PERCENTILE FROM THE COLUMN ON THE RIGHT.

STEP 3: IS THE PATIENT'S SCORE IN OR ABOVE THE RANGE (Premorbid Estimate) THAT YOU ESTABLISHED IN STEP 1? IF SO, NO FURTHER ANALYSIS IS REQUIRED. THE PATIENT IS NOT LIKELY SHOWING ANY MEASURABLE DECLINE FROM PREVIOUS LEVELS. THEREFORE, SIGNIFICANT DEMENTIA IS UNLIKELY.

ON THE OTHER HAND, IF THE PATIENT'S CURRENT LEVEL OF FUNCTIONING IS BELOW YOUR ESTIMATED PREMORBID LEVEL, MOVE ON TO STEP 4. (See FAQ 2.)

STEP 4: NOW COMPARE THE PATIENT'S TOTAL SCORE TO THE DEMENTIA DISTRIBUTION USING THE CHART LABELLED "DEMENTIA".



FREQUENTLY ASKED QUESTIONS:

- 1 **What do I do first?** - The mini-KSCAr is designed to compare an individual's performance to a large number of other people who have already taken the test. In fact, it is used to compare two different groups: healthy NORMAL elderly people living in the community, and people with identified DEMENTIA. The first comparison is always with the NORMALS.
- 2 **Is there a problem?** - Remember, it is from this analysis that one determines whether or not the individual is likely suffering from a dementia.
3. **What if a score falls between two percentiles?** - If the score falls between two percentiles (e.g. a total score of 27 falls between the 45th and 50th percentiles for dementia), one can say that the score is at "approximately the 48th percentile", or falls "just below the 50th percentile", or "just above the 45th percentile".
4. **Can one get half scores?** - It should also be noted that due to Word Recognition, half scores are often possible. For brevity, only some are shown in the percentile conversion charts.
- 5 **Can I use raw scores?** - When comparing a patient to another, or to a group, it is most important to use only **percentiles** (or descriptive ranges) in the discussion and comparison of patients assessed by the mini-KSCAr. Raw scores have no particular meaning and are not directly interpretable, they are used only to calculate the percentiles.

However, when comparing a patient's performance to a previous one, it is appropriate to compare **raw scores**. If the individual previously received the full mini-KSCAr, one only has to compare their previous raw scores to the new mini-KSCAr raw scores.
- 6 **Different charts, different values?** - It should be noted that the percentile conversion charts for each group on the Assessment Form is divided up into intervals of every 5 percentile points (e.g. 30th, 35th, 40th etc.) with the scores calculated to fit them. This often produces scores that are not possible to actually obtain, but are mathematically correct (e.g. 42.7, 43.3). On the other hand, the group charts in the back of this manual use actual scores (e.g. 30, 31, 32 ...) with the corresponding percentiles calculated to fit, and often appear as fractions (e.g. 17.2, 29.3, 70.7...). Quoting percentiles as decimal fractions is mathematically acceptable.
- 6 **My patient couldn't complete all of the subtests. Can I still get any useable information from the mini-KSCAr?** - In clinical practice, this situation can arise with individuals who have significantly impaired vision, such as in cases of advanced cataracts or Macular Degeneration; it can also occur if the person doesn't have sufficient motor control to use a pencil. Alternatively, in very rare cases, a patient may discontinue the test before its completion. In these cases, you can still use the information from any of the subtests that were completely administered. Simply look up the sub-test percentile values that are provided in the manual. You can then comment on where the person is functioning within that sub-test with respect to the percentiles. If you feel that additional testing data are needed, a referral for neuropsychological testing would be appropriate.
- 7 **Percentiles?** At this point, a cautionary note about sub-test percentiles is warranted. As mentioned above in FAQ 2, percentiles, where the range of possible values is limited, often appear very low, and this is especially true in the case of sub-test scores. Again, it has to be remembered that even with a perfect score (e.g. 10 out of 10) the given percentile may be very low (e.g. 6.1). This seemingly strange result arises when, in this example, 93.9% of the sample all scored 10. Therefore, the percentile range is really from 6.1 to 100, but by convention the lower value is used. However, it must be remembered that the true percentile position could be considered 100. A score of one point less (i.e. 9 out of 10) may be listed as at the 2nd percentile. Meaning that it actually has a range from as low as the 2nd and as high as to the 6th percentile.



TOTAL SCORE - PERCENTILES

NORMALS

TOTAL SCORE	PERCENTILE
48.5	95
48	90
45	85
44.7	80
44.3	75
44	70
43.3	65
43	60
42.7	55
42.3	50
42.1	45
42	40
41.5	35
41	30
40.5	25
39.5	20
38	15
37.5	10
37	5

DEMENTIA

TOTAL SCORE	PERCENTILE
38	95
37	90
35	85
34.5	80
33.5	75
32.5	70
30.5	65
29	60
28	55
27.5	50
26.5	45
26	40
25	35
23.5	30
23	25
20.5	20
18.5	15
17	10
14.5	5



NORMAL GROUP

	MEAN	STD DEV	STD ERR	MIN	MAX
AGE OF SUBJECT	72.51	8.21	2.05	62	92
YEARS OF EDUCATION	12.42	3.13	0.70	4	19
WORD RECALL	5.32	1.50	0.36	2	9
ORIENTATION	9.98	0.13	0.03	9	10
ABSTRACT REASONING	7.82	0.39	0.10	7	8
CLOCK TEST	6.72	0.87	0.22	2	7
DELAYED RECALL	4.07	1.76	0.44	0	9
WORD RECOGNITION	8.45	1.11	0.26	5	10
TOTAL SCORE	42.35	3.87	0.97	35	53

n = 60 (Males = 20 (33.3%) Females = 40 (66.7%))

NORMALS - TOTAL SCORE PERCENTILES			
SCORE	PERCENTILE	SCORE	PERCENTILE
53	98.3	41.5	35.6
49	96.6	41	32.2
48.5	94.9	40.5	25.4
48	89.8	40	22
47.5	86.4	39.5	20.3
45	84.8	39	18.6
44.5	78	38.5	17
44	69.5	38	13.6
43.5	67.8	37.5	11.9
43	59.3	37	5.1
42.5	52.5	36	1.7
42	43.4		



DEMENTIA - ALZHEIMER'S DISEASE GROUP

	MEAN	STD DEV	STD ERR	MIN	MAX
AGE OF SUBJECT	78.55	6.03	0.93	58	90
YEARS OF EDUCATION	11.37	3.21	0.50	3	20
DURATION OF ILLNESS	2.72	1.88	0.29	1	10
WORD RECALL	2.47	1.62	0.25	0	7
ORIENTATION	8.16	2.21	0.34	2	10
ABSTRACT REASONING	5.86	2.34	0.36	0	8
CLOCK TEST	3.59	2.38	0.37	0	7
DELAYED RECALL	0.69	1.08	0.17	0	4
WORD RECOGNITION	6.39	2.03	0.31	0	10
TOTAL SCORE	27.16	7.38	1.14	9	41

n = 100 (Males = 31 (31.0%) Females = 69 (39.0%))

ALZHEIMER'S - TOTAL SCORE PERCENTILES			
SCORE	PERCENTILE	SCORE	PERCENTILE
38.5	97	27	47
38	94	26.5	44
37	91	26	38
35.5	88	25.5	37
35	84	25	35
34.5	80	24.5	34
34	77	24	31
33.5	75	23.5	29
33	72	23	24
32.5	71	22.5	19
32	68	20	17
31	66	18.5	14
30	63	17.5	12
29	61	16.5	9
28.5	59	14.5	5
28	53	12	2
27.5	51		



SUB-TEST SCORE PERCENTILES FOR ALZHEIMER'S GROUP

SCORE	%ile	SCORE	%ile	SCORE	%ile
Orientation		Abstract Thinking		Clock Drawing	
9	37	7	53	6	73
8	29	6	38	5	60
7	23	5	24	4	54
6	18	4	22	3	38
5	9.1	3	12	2	26
4	5.1	2	4	1	10
3	1	1	3		
Word Recall		Delayed Recall		Word Recognition	
6	96	3	93	9	92
5	90	2	79	8	76
4	79	1	65	7	54
3	55			6	36
2	28			5	10
1	11			4	5.1

See FAQ 7 on page 19.



mini-KSCAr EDUCATION NORMS (Alzheimer's Group)

	Elementary School (Gr 1 - 8)		High School (Gr 9 -12)		Post Secondary	
	Mean	sd	Mean	sd	Mean	sd
Years of Education	7.23	1.41	11.14	1.08	15.45	1.91
Age	80.29	5.39	78.42	5.78	78.36	5.65
Years of Illness	2.27	2.41	2.84	1.92	2.77	1.79
n	31		50		40	
Males	9		16		24	
Females	22		34		16	
Orientation	8.06	2.08	8.02	2.31	8.73	1.96
Word Recall	2.39	1.54	2.76	1.59	2.80	1.81
Delayed Recall	0.65	1.08	0.80	1.06	0.83	1.26
Word Recognition	6.16	2.10	6.71	1.83	6.54	1.66
Abstract Thinking	4.68	2.80	6.14	2.08	6.90	1.76
Clock Drawing	1.90	1.49	3.84	2.41	4.78	2.13
Total /62	23.84	7.34	28.27	7.44	30.36	6.67
Minimum Score	9		13.5		12.5	
Maximum Score	41		41		40.5	



TOTAL SCORE TO PERCENTILE CONVERSIONS

ELEMENTARY SCHOOL (Alzheimer's Group)

SCORE	PERCENTILE	SCORE	PERCENTILE	SCORE	PERCENTILE
34.5	96.7	26.5	66.7	17.5	20
34	93.3	26	56.7	16.5	16.7
33	90	25.5	53.3	15	13.3
30	86.7	24	50	13	10
29	83.3	23.5	43.3	12	6.7
28	76.7	23	30	10	3.3
27.5	73.3	22.5	26.7		
27	70	18.5	23.3		

HIGH SCHOOL (Alzheimer's Group)

SCORE	PERCENTILE	SCORE	PERCENTILE	SCORE	PERCENTILE
40.5	98	32.5	61.2	23	24.5
39	95.9	30.5	59.2	22.5	18.4
38.5	91.8	29	57.1	20.5	16.3
38	89.8	28.5	55.1	19	14.3
37	85.7	28	49	18.5	12.2
35.5	83.7	27.5	46.9	17.5	10.2
35	77.6	27	42.3	16.5	8.2
34.5	75.5	26.5	38.8	15.5	6.1
34	71.4	26	34.7	15	4.1
33.5	67.4	25	32.7	14.5	2
33	63.3	24	28.6		

POST SECONDARY (Alzheimer's Group)

SCORE	PERCENTILE	SCORE	PERCENTILE	SCORE	PERCENTILE
40	97.4	34	61.5	28	30.8
39.5	94.9	33	59	27	28.2
38	89.7	32	51.3	26.5	25.6
37	87.2	31.5	48.7	26	18
36.5	84.6	31	46.2	25	15.4
35.5	76.9	30	43.6	24.5	12.8
35	74.4	29	38.5	22.5	7.7
34.5	66.7	28.5	35.9	17	5.1



**SUB-TEST SCORE PERCENTILES FOR ELEMENTARY SCHOOL GROUP
(Alzheimer's Group)**

SCORE	%ile	SCORE	%ile	SCORE	%ile
Orientation		Abstract Thinking		Clock Drawing	
9	40	7	67	4	90
8	30	6	57	3	70
7	20	5	47	2	53
5	10	4	43	1	13
4	3.3	3	33		
		2	10		
Word Recall		Delayed Recall		Word Recognition	
4	90	2	83.3	8	80
3	56.7	1	70	7.5	70
2	23.3			7	53.3
1	13.3			6.5	46.7
				6	36.7
				5.5	30
				5	13.3
				4.5	10
				4	6.7

See FAQ 7 on page 19.



SUB-TEST SCORE PERCENTILES FOR HIGH SCHOOL GROUP
 (Alzheimer's Group)

SCORE	%ile	SCORE	%ile	SCORE	%ile
Orientation		Abstract Thinking		Clock Drawing	
9	43	7	49	6	69.4
8	29	6	38.8	5	53
7	27	5	18.4	4	51
6	23	4	16.3	3	32.7
5	10	3	6.1	2	22.5
4	6.1	2	4.1	1	12.2
3	2				
Word Recall		Delayed Recall		Word Recognition	
5	90	3	96	9.5	92
4	71	2	78	9	84
3	45	1	55	8.5	80
2	23			8	74
1	8.2			7.5	71
				7	53.1
				6.5	43
				6	32.7
				5	14.3
				5	10.2
				4.5	4.1

* See FAQ 7 on page 19.



**SUB-TEST SCORE PERCENTILES FOR POST SECONDARY SCHOOL
(Alzheimer's Group)**

SCORE	%ile	SCORE	%ile	SCORE	%ile
Orientation		Abstract Thinking		Clock Drawing	
9	28.2	7	33.3	6	56.4
8	20.5	6	15.4	5	46.2
7	15.4	5	10.3	4	30.8
6	7.7	3	8	3	15.4
4	5.1				
Word Recall		Delayed Recall		Word Recognition	
4	74.4	3	87.2	8	76.9
3	56.4	2	74.4	7.5	64.1
2	33.3	1	66.7	7	48.7
1	10.3			6.5	46.2
				6	30.8
				5.5	17.9
				5	7.7
				4.5	5.1
				4	2.6

* See FAQ 7 on page 19.



OTHER DEMENTIAS GROUP

	MEAN	STD DEV	STD ERR	MIN	MAX
AGE OF SUBJECT	75.13	7.71	1.19	57	94
YEARS OF EDUCATION	11.67	3.32	0.56	4	20
DURATION OF ILLNESS	2.50	1.98	0.31	0	10
WORD RECALL	3.44	1.70	0.26	0	8
ORIENTATION	9.17	1.16	0.18	5	10
ABSTRACT REASONING	6.59	1.65	0.26	2	8
CLOCK TEST	4.44	2.35	0.36	0	7
DELAYED RECALL	1.39	1.58	0.24	0	6
WORD RECOGNITION	6.77	1.85	0.29	2	10
TOTAL SCORE	31.81	6.59	1.02	18	47

n = 54 (Males = 24 (44.4%) Females = 30 (55.6%))

OTHER DEMENTIAS GROUP - TOTAL SCORE PERCENTILES					
SCORE	PERCENTILE	SCORE	PERCENTILE	SCORE	PERCENTILE
46	98.1	34.5	67.9	29	30.2
43.6	94.3	34	66	28.5	26.4
41.5	90.6	33.5	62.3	27.5	22.6
41	88.7	33	60.4	27	20.8
40.5	86.8	32	56.6	26.5	18.9
40	84.9	31.5	54.7	25	15.1
39	83	31	49.1	24.5	11.3
36	79.3	30.5	47.2	24	9.4
35.5	71.7	30	43.4	23	7.6
35	69.8	29.5	41.5	22	3.8



SUB-TEST SCORE PERCENTILES FOR OTHER DEMENTIAS GROUP

SCORE	%ile	SCORE	%ile	SCORE	%ile
Orientation		Abstract Thinking		Clock Drawing	
9	28	7	45	6	59
8	9.4	6	21	5	45
7	1.9	5	13	4	40
		4	7.6	3	22
		3	1.9	2	15
				1	7.6
Word Recall		Delayed Recall		Word Recognition	
6	89	4	93	9	87
5	77	3	79	8	72
4	57	2	55	7	49
3	30	1	47	6	25
2	7.6			5	13
1	5.7			4	5.7

* See FAQ 7 on page 19.



DEPRESSION GROUP

	MEAN	STD DEV	STD ERR	MIN	MAX
AGE OF SUBJECT	76.25	6.94	1.07	66	89
YEARS OF EDUCATION	11.16	2.83	0.44	6	17
DURATION OF ILLNESS	14.85	14.32	2.21	1	53
ORIENTATION	9.91	0.39	0.06	8	10
WORD RECALL	3.50	1.39	0.21	0	6
ABSTRACT REASONING	6.75	1.74	0.27	1	8
CLOCK TEST	5.63	1.64	0.25	2	7
DELAYED RECALL	2.44	1.44	0.22	0	5
WORD RECOGNITION	7.77	1.24	0.19	5	10
TOTAL SCORE	35.98	4.65	0.72	29	44

n = 32 (Males = 11 (34.4%) Females = 21 (65.6%))

SCORE	PERCENTILE	SCORE	PERCENTILE
44	100	36.5	54.8
42.5	87	36	41.9
41.5	83.9	35	38.7
40.5	80.7	34	35.5
40	77.4	33	32.3
39	71	32	29
38.5	67.7	31.5	22.6
38	64.5	31	16.1
37.5	61.3	30.5	12.9
37	58.1	29.5	9.7



SUB-TEST SCORE PERCENTILES FOR DEPRESSION GROUP

SCORE	%ile	SCORE	%ile	SCORE	%ile
Orientation		Abstract Thinking		Clock Drawing	
9	3.2	7	38.7	6	41.9
		6	19.4	5	22.6
		5	9.7	4	16.1
		4	6.5	3	6.5
		3	3.2		
Word Recall		Delayed Recall		Word Recognition	
5	83.9	4	80.7	9	77.4
4	48.4	3	48.4	8.5	67.7
3	22.6	2	22.6	8	54.8
2	6.5	1	16.1	7.5	45.2
1	3.2			7	16.1
				6.5	9.7
				6	3.2

See FAQ 7 on page 19.

Normative Groups Frequency Distributions

